

DEALER



SWITCHGEARS

TENCO GROUP

Mobile: +91 982-671-9220 Website: www.tencogroup.net

PRICE LIST



THE **GLOBAL SPECIALIST**
IN ELECTRICAL AND DIGITAL BUILDING INFRASTRUCTURES

APRIL
2015





Power

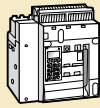

P. 07
DMX³ ACB from
630 A to 2500 A
Fixed version
Draw-out version

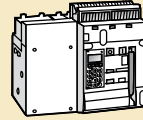

P. 08
DMX³ ACB from
3200 A to 4000 A
Fixed version
Draw-out version

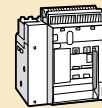

P. 08
DMX³ ACB from
5000 to 6300 A
Fixed version
Draw-out version



P. 13
DRX MCCBs

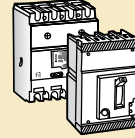

P. 14-25 **NEW!**
DPX³-DPX MCCBs
and Earth leakage
modules



P. 25
Residual
current relay
and Coils



P. 26 **NEW!**
Reactors and
power factor
controllers



**Protection,
Isolation,
Controlling,
Signalling,
Metering.**

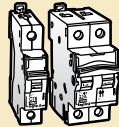

P. 30-33 **NEW!**
DX³ MCB
Isolator
RCDs

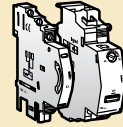

P. 34 **NEW!**
DX³
Accessories
& Auxillaries

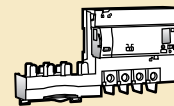

P. 34 **NEW!**
DX³ RCD
add-on module
with metering



P. 40-41
Lexic motor
protection circuit
breakers &
Accessories

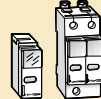

P. 41
Lexic voltage
surge protectors &
Accessories

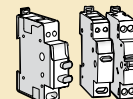

P. 41-42
Lexic changeover
switches, Push
buttons &
Indicators

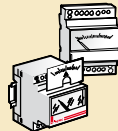

P. 42-43
Lexic ammeters
& Current
transformers



P. 43
Lexic voltmeters &
Selector switches

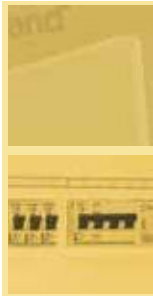

**Ekinoxe™
Distribution
Boards**

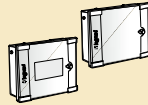

P. 46
SPN DBs

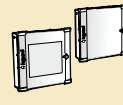

P. 46
ETPN DBs

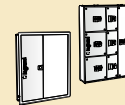

P. 46
7 segment
DBs

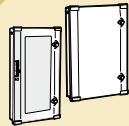

P. 47
Flexy DBs



P. 48
Ekinoxe DBs
Plexo³ boxes
for DX³/Lexic



P. 48
Metra plug and
socket DBs



**Arteor™
Wiring
Accessories**



P. 66
Switches,
Push buttons &
Accessories

Square - white mechanisms

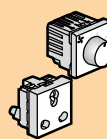

P. 66
Dimmers,
Fan regulators
& Indian standard
sockets

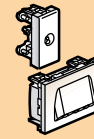

P. 66-67
Information
outlets, TV sockets,
Skirting light and
Power strip



P. 68-69
Switches,
Push buttons &
Accessories

Square - magnesium mechanisms

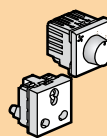

P. 69
Dimmers,
Fan regulators
& Indian standard
sockets

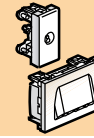

P. 69
Information
outlets, TV sockets,
Skirting light and
Power strip

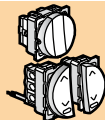

P. 61-71
Switches,
Push buttons &
Accessories

Round - white mechanisms

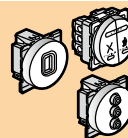

P. 71
Information outlets,
Hotel DND & MMR



P. 72
Electronic dimmers,
Audio-Video sockets
& Micro switches

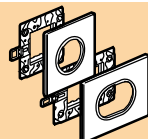

P. 75-77
Round cover
plates

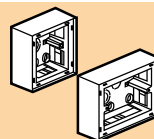

P. 77
Plastic surface
boxes

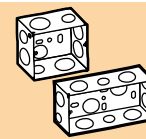

P. 77
Metal flush
boxes

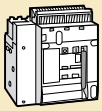

P. 08
DMX[®] ACB trip free switches from 1250A to 6300A Fixed version Draw-out version



P. 09
Microprocessor based protection unit & Accessories

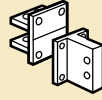

P. 09
DMX[®] Rear terminals and Transformation kit

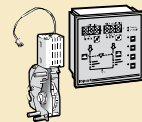

P. 10
DMX[®] ACB auxiliaries and Accessories

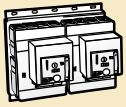

P. 25 **NEW!**
DPX[®] Automatic transfer switch

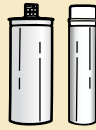

P. 26 **NEW!**
Alpican resin filled capacitors
Standard duty 440 V
Heavy duty 440 V



P. 26 **NEW!**
Alpican gas filled capacitors
Heavy duty 440 V

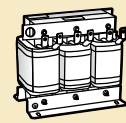

P. 26 **NEW!**
Alpican resin filled capacitors for reactors
Standard duty 525 V

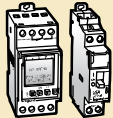

P. 35 **NEW!**
DX[®] Time switches & Contactor

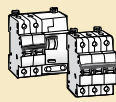

P. 37-38
Lexic MCBs
Isolators
Lexic RCDs



P. 38
Lexic
Railway MCBs

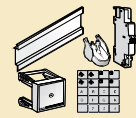

P. 40
Lexic Accessories & Auxiliaries

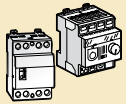

P. 42
Lexic dimmer & Power contactors



P. 42
Lexic
Time delay relay

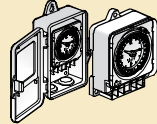

P. 42
Time switches & Accessories



P. 42
Time lag switches

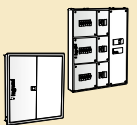

P. 47
7 segment
MCCB DBs



P. 46
Phase selector
DBs

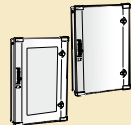

P. 47
VTPN DBs

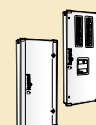

P. 47
DPX[®] MCCB DBs
DPX[®] 250 ER
MCCB DBs



P. 48
P17 Temptra plug and Socket DBs

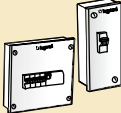

P. 48
Metal one way enclosures

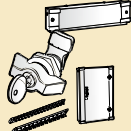

P. 48-50
Cable end box,
Meter box,
PPI Kit &
Accessories

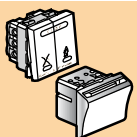

P. 67
Hotel DND & MMR, Keycard, Shaver socket

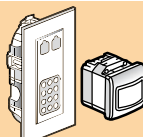

P. 67
Infrared sensors, Clockcon, Keycode, and Time switch

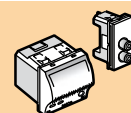

P. 67
Audio-video sockets, Gas & flood detector and Accessories

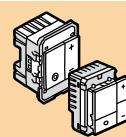

P. 68
Electronic dimmers, Micro switches, Splitters & Access point

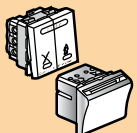

P. 70
Hotel DND & MMR, Keycard, Shaver socket

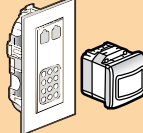

P. 70
Infrared sensors, Clockcon, Keycode, and Time switch

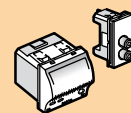

P. 70
Audio-video sockets, Gas & flood detector and Accessories

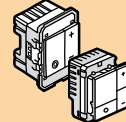

P. 70
Electronic dimmers, Micro switches, Splitters & Access point

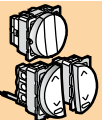

P. 72
Switches, Push buttons & Accessories

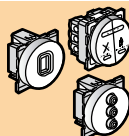

P. 73
Dimmers, Information outlets, Hotel DND & MMR, Audio-video sockets



P. 73
Electronic dimmers & Micro switches

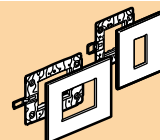

P. 73-75
Square cover plates

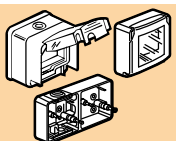

P. 77
IP 55 Plexo boxes and Accessories

Round - magnesium mechanisms



Myrius™ Wiring Accessories

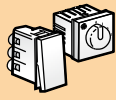

White mechanisms

P. 82
Switches, Push buttons,
Sockets, Power units
and Dimmer &
regulators



P. 83
ELU / Indicators,
Skirting light, Indicators,
Buzzors, Sensors and
Remote unit



P. 83
Hospitality functions,
Sockets & connectors,
Data & voice and Audio
& video connectors

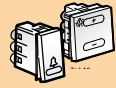

Black mechanisms

P. 85
Switches, Push buttons,
Sockets, Power units
and Dimmer &
regulators

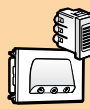

P. 86
ELU / Indicators,
Skirting light, Indicators,
Buzzors, Sensors and
Remote unit

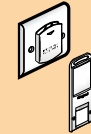

P. 87
Hospitality functions,
Sockets & connectors,
Data & voice and Audio
& video connectors



Mylinc™ Wiring Accessories

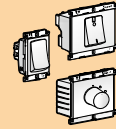

P. 90
Mylinc switches,
Dimmers &
Accessories

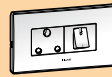

P. 90
Mylinc energy
sockets and
Power units

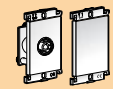

P. 90
Mylinc TV and
RJ 11 telephone
sockets and
Accessories

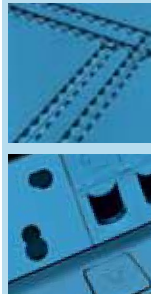

Cable Management System and Accessories

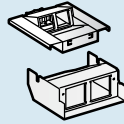

P. 94-96 **NEW!**
Soluflex cable
floor system
37/60/90/120 mm
height

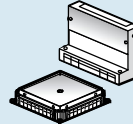

P. 97-98 **NEW!**
Raceways & junction
boxes for screed
floors PVC, Metal &
Accessories

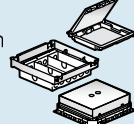

P. 98 **NEW!**
Floor boxes
for raised floor,
Screed floor &
tile/marble

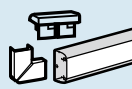

P. 103-104
DLP U-PVC Trunking
System, Trunking,
Mini-Trunking &
Accessories

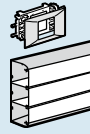

P. 105-106
DLP U-PVC
Adaptable
Trunking system
& Accessories

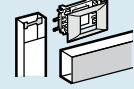

P. 107
DLP Aluminium
Adaptable Trunking
System, Aluminium
Snap-on columns



VDI Structured Cabling

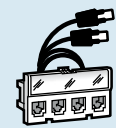

P. 116
LCS², cat. 6A
Patch panels,
Cables &
Cords

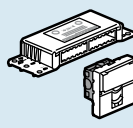

P. 116
LCS², cat. 6A
Zone distribution
boxes, RJ 45
sockets



P. 116-117
LCS², cat. 6
Patch panels,
Cables & Cords

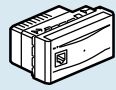

P. 121-122
Wi-Fi
solution

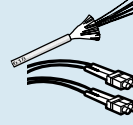

P. 122-124
LCS²
Fibre optic

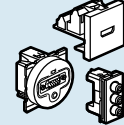

P. 124-125
Audio & video
sockets,
HD 15 amplifier



Movement Detectors and Door Phones



P. 130
Movement
detectors

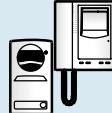

P. 130 **NEW!**
Video door entry
system



P17 Tempra Pro, Hypra and Plugs & Sockets

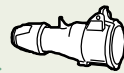

P. 132 **NEW!**
P17 Tempra Pro
sockets

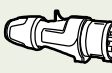

P. 132 **NEW!**
P17 Tempra Pro
plugs



P. 133 **NEW!**
P17 Tempra Pro
for refrigerated
container

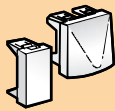

P. 83
Volume controller,
Protectors and
Accessories

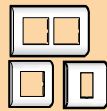

P. 84
White plastic plates

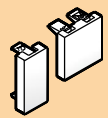

P. 84
Antibacterial
switches +
accessories

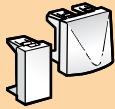

P. 87
Volume controller,
Protectors and
Accessories

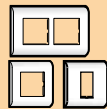

P. 88
Black plastic plates

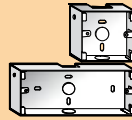

P. 88
Flush mounting &
Surface boxes

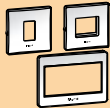

P. 91
Mylinec modular
Plates - White &
Color and Surrounds

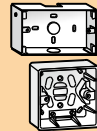

P. 91
Mylinec flush &
Surface boxes

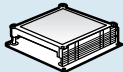

P. 98 **NEW!**
Floor boxes 3 module,
Heavy Duty in-screed
floor box, Floor access
unit for raised floors



P. 99 **NEW!**
Pop-up type flush-
mounting boxes,
Power & data desk
Grommets

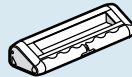

P. 100 **NEW!**
Desktop multi-outlet
extensions, Flush
mounting power &
data module

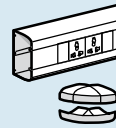

P. 100-101
Snap-On
Trunking 45mm,
Routing sections
& Accessories

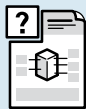

P. 108-109
Selection Chart:
Snap-On trunking

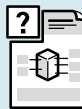

P. 110-111
Selection chart:
DLP U-PVC
adaptable
trunking system



P. 111
Selection Chart:
DLP Mini Trunking
Systems



P. 112-113
Selection Chart :
DLP aluminium
Trunking system

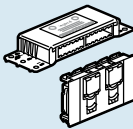

P. 117-118
LCS², cat. 6
Zone distribution
boxes, RJ 45 soc-
kets

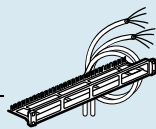

P. 119
LCS², cat. 5e
Patch panels,
Cables &
Cords

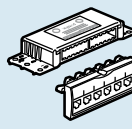

P. 119-120
LCS², cat. 5e
Zone distribution
boxes, RJ 45
sockets

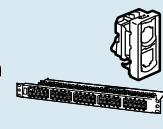

P. 120-121
LCS², Modular
panels, Doubler
sockets, Telephone
panels

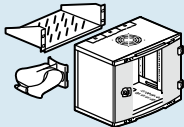

P. 125-128
Enclosure,
Cabinets



P. 134
Hypra industrial
plugs & sockets

Optimized performance up to 6300 A

DMX³ air circuit breakers are available in three frame sizes for three breaking capacities: 50 kA for the DMX³ N designation, 65 kA for DMX³ H and 100 kA for DMX³ L.

The range covers 11 rated currents, between 630 A and 6300 A.

The entire range of DMX³ air circuit breakers are available in fixed and draw-out version.

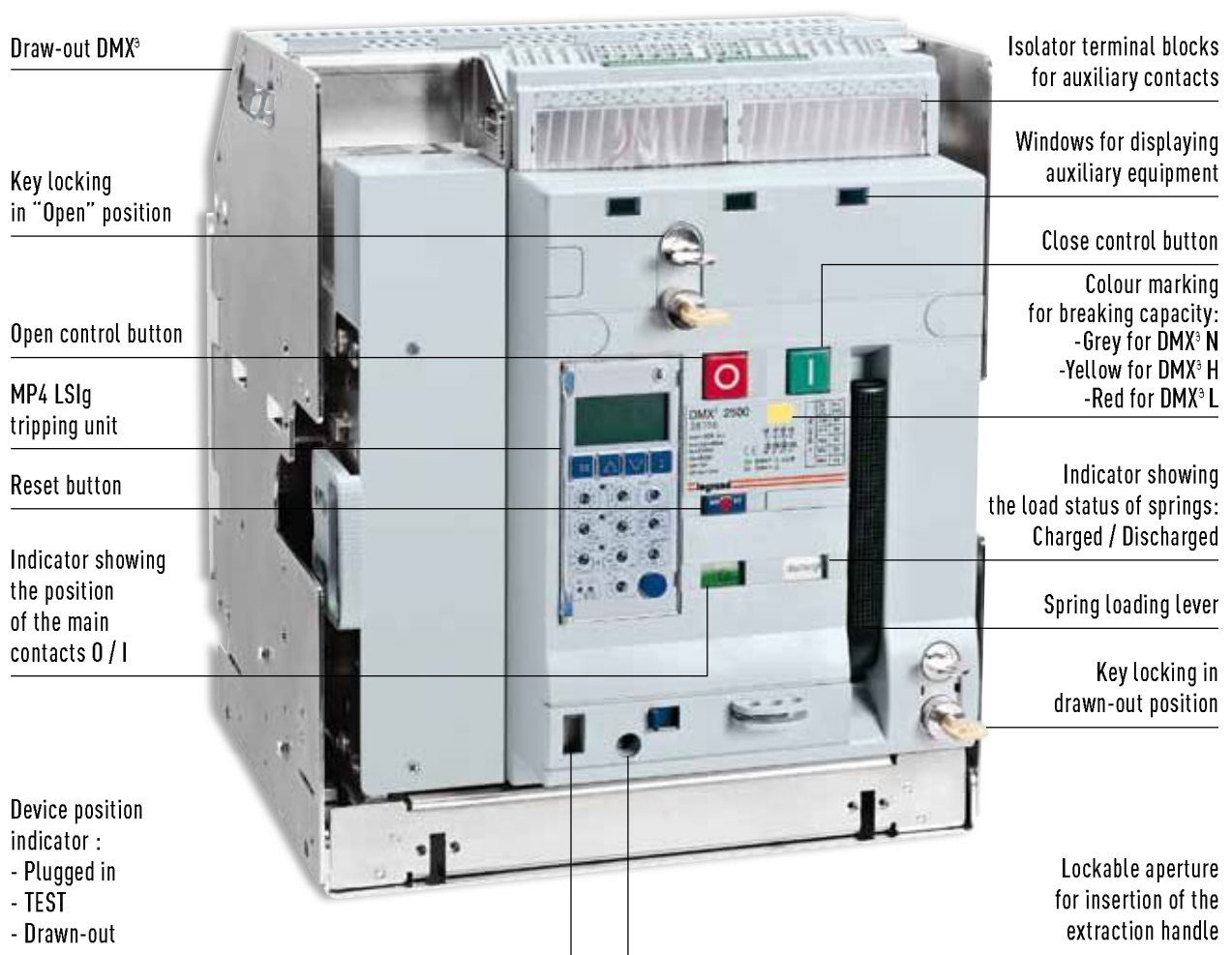

DMX³

air circuit breakers from 630 to 2500 A

Type and frame size	Amps.	Poles	Cat.Nos	Price ₹ / Unit	Pack	
Fixed version						
DMX ³ - N 2500, Icu 50 kA Frame - 1	630 A	3 Pole	0286 20	■	1	
	800 A	3 Pole	0286 21	■	1	
	1000 A	3 Pole	0286 22	■	1	
	1250 A	3 Pole	0286 23	■	1	
	1600 A	3 Pole	0286 24	■	1	
	2000 A	3 Pole	0286 25	■	1	
	2500 A	3 Pole	0286 26	■	1	
	630 A	4 Pole	0286 30	■	1	
	800 A	4 Pole	0286 31	■	1	
	1000 A	4 Pole	0286 32	■	1	
	1250 A	4 Pole	0286 33	■	1	
	1600 A	4 Pole	0286 34	■	1	
	2000 A	4 Pole	0286 35	■	1	
	2500 A	4 Pole	0286 36	■	1	
	DMX ³ - H 2500, Icu 65 kA Frame - 1	630 A	3 Pole	0286 40	■	1
		800 A	3 Pole	0286 41	■	1
1000 A		3 Pole	0286 42	■	1	
1250 A		3 Pole	0286 43	■	1	
1600 A		3 Pole	0286 44	■	1	
2000 A		3 Pole	0286 45	■	1	
2500 A		3 Pole	0286 46	■	1	
630 A		4 Pole	0286 50	■	1	
800 A		4 Pole	0286 51	■	1	
1000 A		4 Pole	0286 52	■	1	
1250 A		4 Pole	0286 53	■	1	
1600 A		4 Pole	0286 54	■	1	
2000 A		4 Pole	0286 55	■	1	
2500 A		4 Pole	0286 56	■	1	
DMX ³ - L 2500, Icu 100 kA Frame - 2		630 A	3 Pole	0286 60	■	1
		800 A	3 Pole	0286 61	■	1
	1000 A	3 Pole	0286 62	■	1	
	1250 A	3 Pole	0286 63	■	1	
	1600 A	3 Pole	0286 64	■	1	
	2000 A	3 Pole	0286 65	■	1	
	2500 A	3 Pole	0286 66	■	1	
	630 A	4 Pole	0286 70	■	1	
	800 A	4 Pole	0286 71	■	1	
	1000 A	4 Pole	0286 72	■	1	
	1250 A	4 Pole	0286 73	■	1	
	1600 A	4 Pole	0286 74	■	1	
	2000 A	4 Pole	0286 75	■	1	
	2500 A	4 Pole	0286 76	■	1	



0286 56

■ Price available on request.

DMX³

air circuit breakers from 630 to 2500 A

Type and frame size	Amps.	Poles	Cat.Nos	Price ₹ / Unit	Pack	
Draw-out version						
DMX ³ - N 2500, Icu 50 kA Frame - 1	630 A	3 Pole	0287 20	■	1	
	800 A	3 Pole	0287 21	■	1	
	1000 A	3 Pole	0287 22	■	1	
	1250 A	3 Pole	0287 23	■	1	
	1600 A	3 Pole	0287 24	■	1	
	2000 A	3 Pole	0287 25	■	1	
	2500 A	3 Pole	0287 26	■	1	
	630 A	4 Pole	0287 30	■	1	
	800 A	4 Pole	0287 31	■	1	
	1000 A	4 Pole	0287 32	■	1	
	1250 A	4 Pole	0287 33	■	1	
	1600 A	4 Pole	0287 34	■	1	
	2000 A	4 Pole	0287 35	■	1	
	2500 A	4 Pole	0287 36	■	1	
	DMX ³ - H 2500, Icu 65 kA Frame - 1	630 A	3 Pole	0287 40	■	1
		800 A	3 Pole	0287 41	■	1
1000 A		3 Pole	0287 42	■	1	
1250 A		3 Pole	0287 43	■	1	
1600 A		3 Pole	0287 44	■	1	
2000 A		3 Pole	0287 45	■	1	
2500 A		3 Pole	0287 46	■	1	
630 A		4 Pole	0287 50	■	1	
800 A		4 Pole	0287 51	■	1	
1000 A		4 Pole	0287 52	■	1	
1250 A		4 Pole	0287 53	■	1	
1600 A		4 Pole	0287 54	■	1	
2000 A		4 Pole	0287 55	■	1	
2500 A		4 Pole	0287 56	■	1	
DMX ³ - L 2500, Icu 100 kA Frame - 2		630 A	3 Pole	0287 60	■	1
		800 A	3 Pole	0287 61	■	1
	1000 A	3 Pole	0287 62	■	1	
	1250 A	3 Pole	0287 63	■	1	
	1600 A	3 Pole	0287 64	■	1	
	2000 A	3 Pole	0287 65	■	1	
	2500 A	3 Pole	0287 66	■	1	
	630 A	4 Pole	0287 70	■	1	
	800 A	4 Pole	0287 71	■	1	
	1000 A	4 Pole	0287 72	■	1	
	1250 A	4 Pole	0287 73	■	1	
	1600 A	4 Pole	0287 74	■	1	
	2000 A	4 Pole	0287 75	■	1	
	2500 A	4 Pole	0287 76	■	1	



0287 56

Bold Cat.Nos are products normally available with Legrand (India) Stockists. Cat.Nos that are not bold - delivery within 4 - 8 weeks from the date of order. Bold packing quantity is our mandatory packing. Orders to be placed by Legrand (India) Stockist in multiples of the same.

DMX³ air circuit breakers from 3200 to 4000 A

Type and frame size	Amps.	Poles	Cat.Nos	Price ₹ / Unit	Pack
Fixed version					
DMX ³ -N 4000	3200 A	3 Pole	0286 27	■	1
Icu 50 kA	4000 A	3 Pole	0286 28	■	1
Frame - 2	3200 A	4 Pole	0286 37	■	1
	4000 A	4 Pole	0286 38	■	1
DMX ³ -H 4000	3200 A	3 Pole	0286 47	■	1
Icu 65 kA	4000 A	3 Pole	0286 48	■	1
Frame - 2	3200 A	4 Pole	0286 57	■	1
	4000 A	4 Pole	0286 58	■	1
DMX ³ -L 4000	3200 A	3 Pole	0286 67	■	1
Icu 100 kA	4000 A	3 Pole	0286 68	■	1
Frame - 2	3200 A	4 Pole	0286 77	■	1
	4000 A	4 Pole	0286 78	■	1



0286 37

Draw-out version

DMX ³ -N 4000	3200 A	3 Pole	0287 27	■	1
Icu 50 kA	4000 A	3 Pole	0287 28	■	1
Frame - 2	3200 A	4 Pole	0287 37	■	1
	4000 A	4 Pole	0287 38	■	1
DMX ³ -H 4000	3200 A	3 Pole	0287 47	■	1
Icu 65 kA	4000 A	3 Pole	0287 48	■	1
Frame - 2	3200 A	4 Pole	0287 57	■	1
	4000 A	4 Pole	0287 58	■	1
DMX ³ -L 4000	3200 A	3 Pole	0287 67	■	1
Icu 100 kA	4000 A	3 Pole	0287 68	■	1
Frame - 2	3200 A	4 Pole	0287 77	■	1
	4000 A	4 Pole	0287 78	■	1

Air circuit breakers from 5000 to 6300 A

Fixed version

DMX ³ -L 6300	5000 A	3 Pole	0289 50	■	1
Icu 100 kA	6300 A	3 Pole	0289 51	■	1
Frame - 3	5000 A	4 Pole	0289 60	■	1
	6300 A	4 Pole	0289 61	■	1

■ Price available on request.

DMX³ air circuit breakers from 5000 to 6300 A

Type and frame size	Amps.	Poles	Cat.Nos	Price ₹ / Unit	Pack
Draw-out version					
DMX ³ -L 6300	5000 A	3 Pole	0289 52	■	1
Icu 100 kA	6300 A	3 Pole	0289 53	■	1
Frame - 3	5000 A	4 Pole	0289 62	■	1
	6300 A	4 Pole	0289 63	■	1

Trip free switches from 1250 to 6300 A

Fixed version

DMX ³ -I 2500	1250 A	3 Pole	0286 83	■	1	
Frame - 1	1600 A	3 Pole	0286 84	■	1	
	2000 A	3 Pole	0286 85	■	1	
	2500 A	3 Pole	0286 86	■	1	
Frame - 2	1250 A	4 Pole	0286 93	■	1	
	1600 A	4 Pole	0286 94	■	1	
	2000 A	4 Pole	0286 95	■	1	
	2500 A	4 Pole	0286 96	■	1	
DMX ³ -I 4000	3200 A	3 Pole	0286 87	■	1	
	Frame - 2	4000 A	3 Pole	0286 88	■	1
		3200 A	4 Pole	0286 97	■	1
4000 A	4 Pole	0286 98	■	1		
DMX ³ -I 6300	6300 A	3 Pole	0289 70	■	1	
	Frame - 3	6300 A	4 Pole	0289 71	■	1



0286 96

Draw-out version

DMX ³ -I 2500	1250 A	3 Pole	0287 83	■	1	
Frame - 1	1600 A	3 Pole	0287 84	■	1	
	2000 A	3 Pole	0287 85	■	1	
	2500 A	3 Pole	0287 86	■	1	
Frame - 2	1250 A	4 Pole	0287 93	■	1	
	1600 A	4 Pole	0287 94	■	1	
	2000 A	4 Pole	0287 95	■	1	
	2500 A	4 Pole	0287 96	■	1	
DMX ³ -I 4000	3200 A	3 Pole	0287 87	■	1	
	Frame - 2	4000 A	3 Pole	0287 88	■	1
		3200 A	4 Pole	0287 97	■	1
4000 A	4 Pole	0287 98	■	1		
DMX ³ -I 6300	6300 A	3 Pole	0289 77	■	1	
	Frame - 3	6300 A	4 Pole	0289 78	■	1



0287 96

Bold Cat.Nos are products normally available with Legrand (India) Stockists. Cat.Nos that are not bold - delivery within 4 - 8 weeks from the date of order. Bold packing quantity is our mandatory packing. Orders to be placed by Legrand (India) Stockist in multiples of the same.

DMX³ microprocessor based protection units

Cat.Nos	Description	Price ₹ / Unit	Pack
---------	-------------	----------------------	------

Microprocessor based protection units MP4 LSI

0288 01	Microprocessor based protection unit with LCD screen with lm, tm, lr, tr and li adjustments on the front	■	1
0288 02	Microprocessor based protection unit with LCD screen with lm, tm, lr, tr, li, lg and tg adjustments on the front	■	1



0288 02

Microprocessor based protection units MP6 LSIg

0288 03	Microprocessor based protection unit with Touch screen with lm, tm, lr, tr and li, adjustments on the front	■	1
0288 04	Microprocessor based protection unit with Touch screen with lm, tm, lr, tr, li, lg and tg adjustments on the front	■	1



0288 03

Accessories for electronic protection units

0288 05	Communication module (optional) for DMX ³ electronic protection units	■	1
0288 06	12 V DC external power supply for DMX ³ electronic protection units	■	1
0288 10	External neutral CT for DMX ³ 6300	■	1
0288 11 ⁽¹⁾	External neutral CT	■	1
0288 12	Module programmable output	■	1

Rear terminals for Frame - 1 and Frame - 2

Type and frame size	Poles	Cat.Nos	Price ₹ / Unit	Pack
---------------------	-------	---------	----------------------	------

Rear terminals

DMX ³ 2500, fixed version, frame - 1	3 Pole	0288 84	■	1
	3 Pole	0288 82	■	1
	4 Pole	0288 85	■	1
	4 Pole	0288 83	■	1
DMX ³ 4000, DMX ³ 6300 fixed version, frame - 2 & 3	3 Pole	0288 92	■	1
	4 Pole	0288 93	■	1
DMX ³ 2500, draw-out version, frame-1	3 Pole	0288 96	■	1
	4 Pole	0288 97	■	1
DMX ³ 4000, DMX ³ 6300 draw-out version, fram - 2 & 3	3 Pole	0288 94	■	1
	4 Pole	0288 95	■	1
DMX ³ 2500, draw-out version, frame-1 suitable for Aluminium	3 Pole	0288 96A	■	1
	4 Pole	0288 97A	■	1
DMX ³ 4000, DMX ³ 6300 draw-out version, frame - 2&3, suitable for Aluminium	3 Pole	0288 94A	■	1
	4 Pole	0288 95A	■	1



0288 84



0288 82



0288 96

■ Price available on request.

(1) Optional accessories to be ordered while ordering electronic protection unit and DMX³ air circuit breakers for factory assembly

DMX³ rear terminals for Frame - 1 and Frame - 2

Type and frame size	Poles	Cat.Nos	Price ₹ / Unit	Pack
---------------------	-------	---------	----------------------	------

Spreaders

DMX ³ 2500, fixed version, frame - 1	3 Pole	0288 86	■	1
	3 Pole	0288 88	■	1
	3 Pole	0288 90	■	1
4 Pole	4 Pole	0288 87	■	1
	4 Pole	0288 89	■	1
4 Pole	4 Pole	0288 91	■	1



0288 91

Equipment for conversion of a fixed device into draw-out device

Bases for draw-out device

DMX ³ /DMX ³ -I 2500, frame - 1	3 Pole	0289 02	■	1
	4 Pole	0289 03	■	1
DMX ³ /DMX ³ -I 4000, frame - 2	3 Pole	0289 04	■	1
	4 Pole	0289 05	■	1
DMX ³ /DMX ³ -I 6300, frame - 3	3 Pole	0289 13	■	1
	4 Pole	0289 14	■	1

Transformation kit for draw-out version

DMX ³ /DMX ³ -I 2500, frame - 1	3 Pole	0289 09	■	1
	4 Pole	0289 10	■	1
DMX ³ /DMX ³ -I 4000, frame - 2	3 Pole	0289 11	■	1
	4 Pole	0289 12	■	1
DMX ³ /DMX ³ -I 6300, frame - 3	3 Pole	0289 15	■	1
	4 Pole	0289 16	■	1

Auxiliaries and accessories

Cat.Nos	Description	Price ₹ / Unit	Pack
---------	-------------	----------------------	------

Control and signalling auxiliaries

Shunt trip

0288 48	24 V \sim /=	■	1
0288 49	48 V \sim /=	■	1
0288 50	110 V \sim /=	■	1
0288 51	230 V \sim /=	■	1
0288 52	415 V \sim	■	1



0288 51

Bold Cat.Nos are products normally available with Legrand (India) Stockists. Cat.Nos that are not bold - delivery within 4 - 8 weeks from the date of order. Bold packing quantity is our mandatory packing. Orders to be placed by Legrand (India) Stockist in multiples of the same.

DMX³ auxiliaries and accessories

Cat.Nos	Description	Price ₹ / Unit	Pack
---------	-------------	----------------------	------

Undervoltage releases

0288 55	24 V \sim /=	■	1
0288 56	48 V \sim /=	■	1
0288 57	110 V \sim /=	■	1
0288 58	230 V \sim /=	■	1
0288 59	415 V \sim	■	1



0288 58

Delayed undervoltage releases

0288 62	110 V \sim /=	■	1
0288 63	230 V \sim /=	■	1

Motor operators

0288 34	24 V \sim /=	■	1
0288 35	48 V \sim /=	■	1
0288 36	110 V \sim /=	■	1
0288 37	230 V \sim /=	■	1
0288 38	415 V \sim	■	1



0288 37

Closing coils

0288 41	24 V \sim /=	■	1
0288 42	48 V \sim /=	■	1
0288 43	110 V \sim /=	■	1
0288 44	230 V \sim /=	■	1
0288 45	415 V \sim	■	1



0288 44

Locking

Key locking in "open" position

0288 31	Ronis lock (key included)	■	1
0288 29	Set of 5 Ronies key barrel	■	1
0288 30	Profalux lock (key included)	■	1
0288 28	2 hole support frame for Ronis locks	■	1

Key locking in the draw-out position

0288 33	Ronis lock (key included)	■	1
0288 32	Profalux lock (key included)	■	1



0288 32
+
0288 33

Door locking

0288 20	Left-hand and right-hand side mounting	■	1
---------	---	---	---

■ Price available on request.

DMX³ auxiliaries and accessories

Cat.Nos	Description	Price ₹ / Unit	Pack
---------	-------------	----------------------	------

Padlocks in "open" position

0288 21	Padlocking system for ACB	■	1
0288 24	Padlocking for button	■	1
0288 26	Padlocking system for shutters	■	1

Automation control unit

0261 93	Standard unit	■	1
0261 94	Communicating unit, enabling data transmission	■	1



0261 93

Equipment for supply invertors

0288 64	Interlock for DMX ³ 2500	■	1
0288 65	Interlock for DMX ³ 4000	■	1
0288 66	Interlock for DMX ³ 6300	■	1



0288 64

Cable interlock

0289 20	Type 1 (2600 mm)	■	1
0289 21	Type 2 (3000 mm)	■	1
0289 22	Type 3 (3600 mm)	■	1
0289 23	Type 4 (4000 mm)	■	1
0289 24	Type 5 (4600 mm)	■	1
0289 25	Type 6 (5600 mm)	■	1

Accessories

0288 25	Rating mis-insertion device	■	1
0288 23	Operations counter	■	1
0288 13	Inserted / test / Draw-out Contact	■	1
0288 14	Contact "ready to close" with charged springs	■	1
0288 15	Set of additional signalling contacts	■	1
0288 16	Signal Contact for Auxiliaries	■	1
0288 22	Door sealing IP 40	■	1
0288 79	Lifting plate	■	1

Bold Cat.Nos are products normally available with Legrand (India) Stockists. Cat.Nos that are not bold - delivery within 4 - 8 weeks from the date of order. **Bold packing quantity** is our mandatory packing. Orders to be placed by Legrand (India) Stockist in multiples of the same.

XL³ enclosure for safety and flexibility

Protection & distribution up to 6300 A



- Totally type-tested system as per IEC 61439-1
- Completely bolted system for ease of assembly
- Modular design for numerous configurations
- Short time current withstand capacity upto 110 kA
- Design suitable for Form 4b
- IP 55 degree of protection also available
- Fire resistance of 750 °C for 30 sec
- Compatible with Zucchini busbar trunking system
- Adjustable plinth height for the better spreading of cables
- Permanent earthing for internal components and external faceplates
- Perfectly house the whole range of Legrand ACBs, MCCBs, Capacitors, MCBs, Metering devices and OMPs like VSP, MPCB etc.

MCCBs: DRX™, DPX³ & DPX™

Legrand now has two distinct ranges of MCCBs

DRX™ -- Thermal magnetic release only.

DPX³ & DPX -- Thermal magnetic and Microprocessor releases.

DRX™, is available upto 100 A, and finds applications in both, residential and commercial. Accessories like the Rotary Handles, Moulded Shrouds, Cage Terminals etc. are available in the range.



DRX 100

Current rating from 60 to 100 A
Breaking Capacity 10 kA
Thermal Magnetic release

DPX³ & DPX is available in 5 frame sizes, covers requirements from 16 A upto 1600 A, with adjustable thermal and magnetic releases. Optional accessories like Rotary Handles, Motor Operators etc. are also available. **DPX³ & DPX** can also be used as an Automatic Transfer Switch.



DPX³ 160

Current rating from 16 to 160 A
Breaking capacity 16 kA to 50 kA
Thermal magnetic release
Optional integrated earth leakage available



DPX³ 250

Current rating 40 Amp to 250 Amp
Breaking capacity 25 kA to 70 kA
Thermal magnetic release & microprocessor release
Optional integrated earth leakage available



DPX 250

Current rating from 25 to 250 A
Breaking capacity 36 kA, 70 kA and 100 kA
Thermal magnetic release

DPX 250 Elect.

Current rating from 40 to 250 A
Breaking capacity 70 kA



DPX 630

Current rating from 400 to 630 A
Breaking capacity 36 kA, 70 kA and 100 kA
Thermal magnetic release

DPX 630 Elect.

Current rating from 160 to 630 A
Breaking capacity 36 kA and 70 kA



DPX 1250

Current rating from 500 to 1250 A
Breaking capacity 50 kA, 70 kA and 100 kA
Thermal magnetic release

DPX 1600 Elect.

Current rating from 630 to 1600 A
Breaking capacity 50 kA and 70 kA

DRX™ MCCB

Type and frame size	Amps.	Poles	Cat.Nos	LP* ₹ / Unit	Pack
---------------------	-------	-------	---------	-----------------	------

DRX MCCBs

DRX 100 Icu = 10 kA	60 A	3 Pole	0270 06	2168	1/12
	63 A	3 Pole	0270 39	2168	1/12
	75 A	3 Pole	0270 07	2168	1/12
	100 A	3 Pole	0270 08	2168	1/12
	60 A	4 Pole	0270 16	3844	1/12
	63 A	4 Pole	0270 29	3844	1/12
	75 A	4 Pole	0270 17	3844	1/12
	100 A	4 Pole	0270 18	3844	1/12

Description	Cat.Nos	LP* ₹ / Unit	Pack
-------------	---------	-----------------	------

DIN rail adaptor

DRX 100	0271 87	366	1
---------	---------	-----	---

Rotary handles - Direct

DRX 100	6271 76	1020	1
---------	---------	------	---

Rotary handles - vary-depth

DRX 100	6271 77	1750	1
---------	---------	------	---

Padlocking support for operating handle

DRX 100	0271 80	112	1
---------	---------	-----	---

Connection accessories

Set of 2 shields for 3 pole	0271 81	88	1
-----------------------------	---------	----	---

Sealable terminal shields (moulded shrouds)

For DRX 100 - 3 pole	0271 83	1176	1
For DRX 100 - 4 pole	0271 84	1232	1

Cage terminals

For DRX 100 - 3 pole	0271 71	214	1
For DRX 100 - 4 pole	0271 73	232	1

Electrical accessories

Block with 1 auxiliary (1 AUX)	0271 40	756	1
Block with 1 alarm (1 AL)	0271 41	762	1
Block with 1 auxiliary + 1 alarm (1 AUX + 1 AL)	0271 42	1268	1

Current shunt coils

200/277 V~ and =	0271 54	1576	1
380/480 V~ and =	0271 55	1576	1

Undervoltage release coils

200/240 V~	0271 64	1828	1
380/415 V~	0271 65	1828	1

DRX spreader links

3 Links set for TP	6250 10	144	1
4 Links set for FP	6250 11	216	1

*LP - List Price Inclusive of excise duty but exclusive of sales tax or any other taxes.

For MCCB Enclosures - refer pg. 47

Red Cat.Nos - new products

P17 TEMPRA AND HYPRA

Safe and simple, Ideal for industry



- > Rated voltages - 240 V AC and 415 V AC
- > Protection categories - IP 44 and IP 66/67
- > Colour coding for voltage identification
Blue Colour for 240 V AC
Red Colour for 415 V AC
- > Material of plugs and sockets special high grade plastic. Shock proof at low and high temperatures.

Refer p. 132-134

Bold Cat.Nos are products normally available with Legrand (India) Stockists. Cat.Nos that are not bold - delivery within 4 - 8 weeks from the date of order. Bold packing quantity is our mandatory packing. Orders to be placed by Legrand (India) Stockist in multiples of the same.

DPX³ 160 thermal magnetic MCCBs from 16 to 160 A

Type and frame sizes	Amps.	Poles	Cat.Nos	LP* ₹ / Unit	Pack
MCCBs					
DPX ³ 160 ① Icu = 16 kA	16 A	3 Pole	4200 00	5682	1
	25 A	3 Pole	4200 01	5530	1
	40 A	3 Pole	4200 02	5154	1
	63 A	3 Pole	4200 03	5154	1
	80 A	3 Pole	4200 04	5154	1
	100 A	3 Pole	4200 05	5006	1
	125 A	3 Pole	4200 06	5622	1
	160 A	3 Pole	4200 07	6746	1
	16 A	4 Pole	4200 10	7260	1
	25 A	4 Pole	4200 11	7162	1
	40 A	4 Pole	4200 12	6640	1
	63 A	4 Pole	4200 13	6504	1
	80 A	4 Pole	4200 14	6504	1
	100 A	4 Pole	4200 15	6432	1
	125 A	4 Pole	4200 16	7174	1
	160 A	4 Pole	4200 17	8604	1
DPX ³ 160 ① Icu = 25 kA	16 A	3 Pole	4200 40	9182	1
	25 A	3 Pole	4200 41	8850	1
	40 A	3 Pole	4200 42	8954	1
	63 A	3 Pole	4200 43	7034	1
	80 A	3 Pole	4200 44	7034	1
	100 A	3 Pole	4200 45	6940	1
	125 A	3 Pole	4200 46	7610	1
	160 A	3 Pole	4200 47	9130	1
	16 A	4 Pole	4200 50	12854	1
	25 A	4 Pole	4200 51	12568	1
	40 A	4 Pole	4200 52	12220	1
	63 A	4 Pole	4200 53	9484	1
	80 A	4 Pole	4200 54	9484	1
	100 A	4 Pole	4200 55	9582	1
	125 A	4 Pole	4200 56	10926	1
	160 A	4 Pole	4200 57	13110	1
DPX ³ 160 ① Icu = 36 kA	16 A	3 Pole	4200 80	11064	1
	25 A	3 Pole	4200 81	10288	1
	40 A	3 Pole	4200 82	10514	1
	63 A	3 Pole	4200 83	7978	1
	80 A	3 Pole	4200 84	7978	1
	100 A	3 Pole	4200 85	8016	1
	125 A	3 Pole	4200 86	9424	1
	160 A	3 Pole	4200 87	12026	1
	16 A	4 Pole	4200 90	13964	1
	25 A	4 Pole	4200 91	12936	1
	40 A	4 Pole	4200 92	13662	1
	63 A	4 Pole	4200 93	11194	1
	80 A	4 Pole	4200 94	11194	1
	100 A	4 Pole	4200 95	10960	1
	125 A	4 Pole	4200 96	12578	1
	160 A	4 Pole	4200 97	15098	1



DPX³ 160 thermal magnetic MCCBs from 16 to 160 A

Type and frame sizes	Amps.	Poles	Cat.Nos	LP* ₹ / Unit	Pack
MCCBs					
DPX ³ 160 ① Icu = 50 kA	16 A	3 Pole	4201 20	12948	1
	25 A	3 Pole	4201 21	11660	1
	40 A	3 Pole	4201 22	12026	1
	63 A	3 Pole	4201 23	9054	1
	80 A	3 Pole	4201 24	9054	1
	100 A	3 Pole	4201 25	9168	1
	125 A	3 Pole	4201 26	11198	1
	160 A	3 Pole	4201 27	15110	1
	16 A	4 Pole	4201 30	16214	1
	25 A	4 Pole	4201 31	13640	1
	40 A	4 Pole	4201 32	16662	1
	63 A	4 Pole	4201 33	15322	1
	80 A	4 Pole	4201 34	15322	1
	100 A	4 Pole	4201 35	14228	1
	125 A	4 Pole	4201 36	16116	1
	160 A	4 Pole	4201 37	19368	1
MCCBs with electronic earth leakage module					
DPX ³ 160 ① Icu = 16 kA	16 A	4 Pole	4200 30	23346	1
	25 A	4 Pole	4200 31	23244	1
	40 A	4 Pole	4200 32	22690	1
	63 A	4 Pole	4200 33	22550	1
	80 A	4 Pole	4200 34	22478	1
	100 A	4 Pole	4200 35	22478	1
	125 A	4 Pole	4200 36	24020	1
	160 A	4 Pole	4200 37	29194	1
DPX ³ 160 ① Icu = 25 kA	16 A	4 Pole	4200 70	29216	1
	25 A	4 Pole	4200 71	28918	1
	40 A	4 Pole	4200 72	28552	1
	63 A	4 Pole	4200 73	25682	1
	80 A	4 Pole	4200 74	25784	1
	100 A	4 Pole	4200 75	25784	1
	125 A	4 Pole	4200 76	27964	1
	160 A	4 Pole	4200 77	33550	1
DPX ³ 160 ① Icu = 36 kA	16 A	4 Pole	4201 10	30382	1
	25 A	4 Pole	4201 11	29304	1
	40 A	4 Pole	4201 12	30066	1
	63 A	4 Pole	4201 13	27476	1
	80 A	4 Pole	4201 14	27226	1
	100 A	4 Pole	4201 15	27226	1
	125 A	4 Pole	4201 16	29696	1
	160 A	4 Pole	4201 17	35564	1
DPX ³ 160 ① Icu = 50 kA	16 A	4 Pole	4201 50	34214	1
	25 A	4 Pole	4201 51	32998	1
	40 A	4 Pole	4201 52	33856	1
	63 A	4 Pole	4201 53	31700	1
	80 A	4 Pole	4201 54	31414	1
	100 A	4 Pole	4201 55	31414	1
	125 A	4 Pole	4201 56	33440	1
	160 A	4 Pole	4201 57	40048	1

*LP-List Price Inclusive of excise duty but exclusive of sales tax or any other taxes.

Bold Cat.Nos are products normally available with Legrand (India) Stockists. Cat.Nos that are not bold - delivery within 4 - 8 weeks from the date of order. Bold packing quantity is our mandatory packing. Orders to be placed by Legrand (India) Stockist in multiples of the same.

DPX³ 250 thermal magnetic

MCCBs from 100 to 250 A

Type and frame sizes	Amps.	Poles	Cat.Nos	LP* ₹ / Unit	Pack
----------------------	-------	-------	---------	-----------------	------

MCCBs

DPX ³ 250 Icu = 25 kA	100 A	3 Pole	4202 05	8504	1
	160 A	3 Pole	4202 07	12758	1
	200 A	3 Pole	4202 08	15776	1
	250 A	3 Pole	4202 09	19718	1
	100 A	4 Pole	4202 15	10632	1
	160 A	4 Pole	4202 17	15950	1
	200 A	4 Pole	4202 18	19718	1
	250 A	4 Pole	4202 19	24646	1
DPX ³ 250 Icu = 36 kA	100 A	3 Pole	4202 35	14968	1
	160 A	3 Pole	4202 37	15950	1
	200 A	3 Pole	4202 38	18306	1
	250 A	3 Pole	4202 39	20038	1
	100 A	4 Pole	4202 45	16064	1
	160 A	4 Pole	4202 47	19970	1
	200 A	4 Pole	4202 48	22346	1
	250 A	4 Pole	4202 49	25654	1
DPX ³ 250 Icu = 50 kA	100 A	3 Pole	4202 65	16132	1
	160 A	3 Pole	4202 67	17764	1
	200 A	3 Pole	4202 68	20598	1
	250 A	3 Pole	4202 69	22400	1
	100 A	4 Pole	4202 75	20426	1
	160 A	4 Pole	4202 77	22336	1
	200 A	4 Pole	4202 78	25630	1
	250 A	4 Pole	4202 79	27864	1
DPX ³ 250 Icu = 70 kA	100 A	3 Pole	4206 05	18314	1
	160 A	3 Pole	4206 07	22946	1
	200 A	3 Pole	4206 08	28112	1
	250 A	3 Pole	4206 09	29832	1
	100 A	4 Pole	4206 15	20652	1
	160 A	4 Pole	4206 17	28684	1
	200 A	4 Pole	4206 18	34420	1
	250 A	4 Pole	4206 19	36142	1

MCCBs with electronic earth leakage module

DPX ³ 250 Icu = 25 kA	100 A	4 Pole	4202 25	35210	1
	160 A	4 Pole	4202 27	41044	1
	200 A	4 Pole	4202 28	43008	1
	250 A	4 Pole	4202 29	45932	1
DPX ³ 250 Icu = 36 kA	100 A	4 Pole	4202 55	39088	1
	160 A	4 Pole	4202 57	45558	1
	200 A	4 Pole	4202 58	47742	1
	250 A	4 Pole	4202 59	50988	1

*LP-List Price Inclusive of excise duty but exclusive of sales tax or any other taxes.



4202 05



4202 25

DPX³ 250 thermal magnetic

MCCBs from 100 to 250 A

Type and frame sizes	Amps.	Poles	Cat.Nos	LP* ₹ / Unit	Pack
----------------------	-------	-------	---------	-----------------	------

MCCBs with electronic earth leakage module

DPX ³ 250 Icu = 50 kA	100 A	4 Pole	4202 85	45626	1
	160 A	4 Pole	4202 87	53182	1
	200 A	4 Pole	4202 88	55984	1
	250 A	4 Pole	4202 89	59426	1
DPX ³ 250 Icu = 70 kA	100 A	4 Pole	4206 25	46366	1
	160 A	4 Pole	4206 27	57962	1
	200 A	4 Pole	4206 28	62690	1
	250 A	4 Pole	4206 29	66240	1

DPX³ 250 electronic release

MCCBs from 40 to 250 A

MCCBs

DPX ³ 250 Icu = 25 kA	40 A	3 Pole	4203 02	14346	1
	100 A	3 Pole	4203 05	14346	1
	160 A	3 Pole	4203 07	18482	1
	250 A	3 Pole	4203 09	25410	1
	40 A	4 Pole	4203 12	19246	1
	100 A	4 Pole	4203 15	19246	1
	160 A	4 Pole	4203 17	24260	1
	250 A	4 Pole	4203 19	32572	1
DPX ³ 250 Icu = 36 kA	40 A	3 Pole	4203 32	15164	1
	100 A	3 Pole	4203 35	15164	1
	160 A	3 Pole	4203 37	19830	1
	250 A	3 Pole	4203 39	27724	1
	40 A	4 Pole	4203 42	20178	1
	100 A	4 Pole	4203 45	20178	1
	160 A	4 Pole	4203 47	27116	1
	250 A	4 Pole	4203 49	36156	1
DPX ³ 250 Icu = 50 kA	40	3 Pole	4203 62	18310	1
	100	3 Pole	4203 65	19288	1
	160	3 Pole	4203 67	23794	1
	250	3 Pole	4203 69	29456	1
	40 A	4 Pole	4203 72	23326	1
	100 A	4 Pole	4203 75	23326	1
	160 A	4 Pole	4203 77	29168	1
	250 A	4 Pole	4203 79	38234	1
DPX ³ 250 Icu = 70 kA	40 A	3 Pole	4206 35	22966	1
	100 A	3 Pole	4206 37	22966	1
	160 A	3 Pole	4206 38	34324	1
	250 A	3 Pole	4206 39	39070	1
	40 A	4 Pole	4206 45	29820	1
	100 A	4 Pole	4206 47	29820	1
	160 A	4 Pole	4206 48	39688	1
	250 A	4 Pole	4206 49	50664	1



4203 69

Bold Cat.Nos are products normally available with Legrand (India) Stockists. Cat.Nos that are not bold - delivery within 4 - 8 weeks from the date of order. Bold packing quantity is our mandatory packing. Orders to be placed by Legrand (India) Stockist in multiples of the same.

DPX³ 250 electronic release MCCBs from 40 to 250 A

Type and frame sizes	Amps.	Poles	Cat.Nos	LP* ₹ / Unit	Pack
----------------------	-------	-------	---------	-----------------	------

MCCBs with electronic earth leakage module

DPX ³ 250 ② Icu = 25 kA	40 A	4 Pole	4203 22	56012	1
	100 A	4 Pole	4203 25	56012	1
	160 A	4 Pole	4203 27	60020	1
	250 A	4 Pole	4203 29	70090	1
DPX ³ 250 ② Icu = 36 kA	40 A	4 Pole	4203 52	56986	1
	100 A	4 Pole	4203 55	56986	1
	160 A	4 Pole	4203 57	62926	1
	250 A	4 Pole	4203 59	73400	1
DPX ³ 250 ② Icu = 50 kA	40 A	4 Pole	4203 82	59994	1
	100 A	4 Pole	4203 85	59994	1
	160 A	4 Pole	4203 87	65116	1
	250 A	4 Pole	4203 89	75690	1
DPX ³ 250 ② Icu = 70 kA	40 A	4 Pole	4206 55	65374	1
	100 A	4 Pole	4206 57	65374	1
	160 A	4 Pole	4206 58	73760	1
	250 A	4 Pole	4206 59	100708	1

MCCBs with energy metering central unit

DPX ³ 250 ② Icu = 25 kA	40 A	3 Pole	4204 02	43586	1
	100 A	3 Pole	4204 05	43586	1
	160 A	3 Pole	4204 07	47212	1
	250 A	3 Pole	4204 09	51072	1
	40 A	4 Pole	4204 12	47620	1
	100 A	4 Pole	4204 15	47620	1
	160 A	4 Pole	4204 17	51544	1
	250 A	4 Pole	4204 19	58726	1
DPX ³ 250 ② Icu = 36 kA	40 A	3 Pole	4204 32	44488	1
	100 A	3 Pole	4204 35	44488	1
	160 A	3 Pole	4204 37	48448	1
	250 A	3 Pole	4204 39	52304	1
	40 A	4 Pole	4204 42	48570	1
	100 A	4 Pole	4204 45	48570	1
	160 A	4 Pole	4204 47	54394	1
	250 A	4 Pole	4204 49	61376	1
DPX ³ 250 ② Icu = 50 kA	40 A	3 Pole	4204 62	47354	1
	100 A	3 Pole	4204 65	47354	1
	160 A	3 Pole	4204 67	51948	1
	250 A	3 Pole	4204 69	54892	1
	40 A	4 Pole	4204 72	51520	1
	100 A	4 Pole	4204 75	51520	1
	160 A	4 Pole	4204 77	56542	1
	250 A	4 Pole	4204 79	63592	1

*LP-List Price Inclusive of excise duty but exclusive of sales tax or any other taxes.



4203 25

DPX³ 250 electronic release MCCBs from 40 to 250 A

Type and frame sizes	Amps.	Poles	Cat.Nos	LP* ₹ / Unit	Pack
----------------------	-------	-------	---------	-----------------	------

MCCBs with energy metering central unit

DPX ³ 250 ② Icu = 70 kA	40 A	3 Pole	4206 65	51108	1
	100 A	3 Pole	4206 67	51108	1
	160 A	3 Pole	4206 68	60964	1
	250 A	3 Pole	4206 69	61066	1
	40 A	4 Pole	420675	56796	1
	100 A	4 Pole	420677	56796	1
	160 A	4 Pole	420678	65018	1
	250 A	4 Pole	420679	88838	1



4206 79

MCCBs with energy metering central unit and electronic earth leakage module

DPX ³ 250 ② Icu = 25 kA	40 A	4 Pole	4204 22	75122	1
	100 A	4 Pole	4204 25	75122	1
	160 A	4 Pole	4204 27	79052	1
	250 A	4 Pole	4204 29	88924	1
DPX ³ 250 ② Icu = 36 kA	40 A	4 Pole	4204 52	76076	1
	100 A	4 Pole	4204 55	76076	1
	160 A	4 Pole	4204 57	81898	1
	250 A	4 Pole	4204 59	91282	1
DPX ³ 250 ② Icu = 50 kA	40 A	4 Pole	4204 82	79024	1
	100 A	4 Pole	4204 85	79024	1
	160 A	4 Pole	4204 87	84046	1
	250 A	4 Pole	4204 89	94410	1
DPX ³ 250 ② Icu = 70 kA	40 A	4 Pole	4206 85	84300	1
	100 A	4 Pole	4206 87	84300	1
	160 A	4 Pole	4206 88	92524	1
	250 A	4 Pole	4206 89	118746	1



4204 25

Electronic release Sg MCCBs

DPX ³ 250 ② Icu = 25 kA	40 A	3 Pole	4205 02	34108	1
	100 A	3 Pole	4205 05	34108	1
	160 A	3 Pole	4205 07	37802	1
	250 A	3 Pole	4205 09	41738	1
	40 A	4 Pole	4205 12	38214	1
	100 A	4 Pole	4205 15	38214	1
	160 A	4 Pole	4205 17	42218	1
	250 A	4 Pole	4205 19	49052	1
DPX ³ 250 ② Icu = 36 kA	40 A	3 Pole	4205 22	35024	1
	100 A	3 Pole	4205 25	35024	1
	160 A	3 Pole	4205 27	39058	1
	250 A	3 Pole	4205 29	42568	1
	40 A	4 Pole	4205 32	39186	1
	100 A	4 Pole	4205 35	39186	1
	160 A	4 Pole	4205 37	45108	1
	250 A	4 Pole	4205 39	52318	1

Bold Cat.Nos are products normally available with Legrand (India) Stockists. Cat.Nos that are not bold - delivery within 4 - 8 weeks from the date of order. Bold packing quantity is our mandatory packing. Orders to be placed by Legrand (India) Stockist in multiples of the same.

DPX³ 250 electronic release

MCCBs from 40 to 250 A

Type and frame sizes	Amps.	Poles	Cat.Nos	LP* ₹ / Unit	Pack
----------------------	-------	-------	---------	-----------------	------

Electronic release Sg MCCBs

DPX ³ 250 ② Icu = 50 kA	40 A	3 Pole	4205 42	37942	1
	100 A	3 Pole	4205 45	37942	1
	160 A	3 Pole	4205 47	42616	1
	250 A	3 Pole	4205 49	45186	1
	40 A	4 Pole	4205 52	42182	1
	100 A	4 Pole	4205 55	42182	1
	160 A	4 Pole	4205 57	47306	1
	250 A	4 Pole	4205 59	54584	1
DPX ³ 250 ② Icu = 70 kA	40 A	3 Pole	4206 92	43016	1
	100 A	3 Pole	4206 95	43016	1
	160 A	3 Pole	4206 97	53354	1
	250 A	3 Pole	4206 99	52954	1
	40 A	4 Pole	4207 02	48984	1
	100 A	4 Pole	4207 05	48984	1
	160 A	4 Pole	4207 07	57606	1
	250 A	4 Pole	4207 09	83504	1



4205 49

NEW!

DPX³ 630

thermal magnetic release
MCCBs from 250 to 630 A

MCCBs thermal magnetic release

DPX ³ 630 ⑤ Icu = 36 kA	320 A	3 Pole	4220 01	24512	1
	400 A	3 Pole	4220 02	24512	1
	500 A	3 Pole	4220 03	28160	1
	630 A	3 Pole	4220 04	30058	1
	320 A	4 Pole	4220 06	30730	1
	400 A	4 Pole	4220 07	30730	1
	500 A	4 Pole	4220 08	35520	1
	630 A	4 Pole	4220 09	37482	1
DPX ³ 630 ⑤ Icu = 50 kA	320 A	3 Pole	4220 15	26070	1
	400 A	3 Pole	4220 16	26154	1
	500 A	3 Pole	4220 17	30614	1
	630 A	3 Pole	4220 18	32810	1
	320 A	4 Pole	4220 20	32214	1
	400 A	4 Pole	4220 21	32650	1
	500 A	4 Pole	4220 22	39210	1
	630 A	4 Pole	4220 23	41600	1
DPX ³ 630 ⑤ Icu = 70 kA	320 A	3 Pole	4220 29	29866	1
	400 A	3 Pole	4220 30	30016	1
	500 A	3 Pole	4220 31	38282	1
	630 A	3 Pole	4220 32	40310	1
	320 A	4 Pole	4220 34	36900	1
	400 A	4 Pole	4220 35	36900	1
	500 A	4 Pole	4220 36	49000	1
	630 A	4 Pole	4220 37	49000	1



4220 02



4220 07

■ Price available on request.

*LP-List Price Inclusive of excise duty but exclusive of sales tax or any other taxes.

Red Cat.Nos - new products

NEW!

DPX³ 630 - thermal magnetic release

MCCBs from 250 to 630 A

Type and frame sizes	Amps.	Poles	Cat.Nos	LP* ₹ / Unit	Pack
----------------------	-------	-------	---------	-----------------	------

MCCBs thermal magnetic release

DPX ³ 630 ⑤ Icu = 1000 kA	320 A	3 Pole	4220 43	■	1
	400 A	3 Pole	4220 44	■	1
	500 A	3 Pole	4220 45	■	1
	630 A	3 Pole	4220 46	■	1
	320 A	4 Pole	4220 48	■	1
	400 A	4 Pole	4220 49	■	1
	500 A	4 Pole	4220 50	■	1
	630 A	4 Pole	4220 51	■	1



4220 60



4220 65

DPX³ 630

S2 electronic release MCCBs from 250 to 630 A

MCCBs electronic release S2

DPX ³ 630 ⑤ Icu = 36 kA	320 A	3 Pole	4220 57	30532	1
	400 A	3 Pole	4220 58	30532	1
	500 A	3 Pole	4220 59	33858	1
	630 A	3 Pole	4220 60	33858	1
	320 A	4 Pole	4220 62	36648	1
	400 A	4 Pole	4220 63	36648	1
	500 A	4 Pole	4220 64	44442	1
	630 A	4 Pole	4220 65	44442	1
DPX ³ 630 ⑤ Icu = 50 kA	320 A	3 Pole	4220 67	32904	1
	400 A	3 Pole	4220 68	32904	1
	500 A	3 Pole	4220 69	36480	1
	630 A	3 Pole	4220 70	41790	1
	320 A	4 Pole	4220 72	41640	1
	400 A	4 Pole	4220 73	41640	1
	500 A	4 Pole	4220 74	48562	1
	630 A	4 Pole	4220 75	48562	1
DPX ³ 630 ⑤ Icu = 70 kA	320 A	3 Pole	4220 77	39244	1
	400 A	3 Pole	4220 78	39244	1
	500 A	3 Pole	4220 79	44352	1
	630 A	3 Pole	4220 80	44352	1
	320 A	4 Pole	4220 82	50804	1
	400 A	4 Pole	4220 83	50804	1
	500 A	4 Pole	4220 84	56740	1
	630 A	4 Pole	4220 85	56740	1
DPX ³ 630 ⑤ Icu = 100 kA	320 A	3 Pole	4220 87	■	1
	400 A	3 Pole	4220 88	■	1
	500 A	3 Pole	4220 89	■	1
	630 A	3 Pole	4220 90	■	1
	320 A	4 Pole	4220 92	■	1
	400 A	4 Pole	4220 93	■	1
	500 A	4 Pole	4220 94	■	1
	630 A	4 Pole	4220 95	■	1

Bold Cat.Nos are products normally available with Legrand (India) Stockists. Cat.Nos that are not bold - delivery within 4 - 8 weeks from the date of order. Bold packing quantity is our mandatory packing. Orders to be placed by Legrand (India) Stockist in multiples of the same.

DPX³ 630

S2 electronic release MCCBs from 250 to 630 A

NEW!

Type and frame sizes	Amps.	Poles	Cat.Nos	LP* ₹ / Unit	Pack
----------------------	-------	-------	---------	-----------------	------

MCCBs electronic release S2 with energy metering central unit

DPX ³ 630 Ⓢ Icu = 36 kA	320 A	3 Pole	4220 97	41532	1
	400 A	3 Pole	4220 98	41532	1
	500 A	3 Pole	4220 99	44858	1
	630 A	3 Pole	4221 00	44858	1
	320 A	4 Pole	4221 02	49648	1
	400 A	4 Pole	4221 03	49648	1
	500 A	4 Pole	4221 04	55442	1
	630 A	4 Pole	4221 05	55442	1
DPX ³ 630 Ⓢ Icu = 50 kA	320 A	3 Pole	4221 07	43904	1
	400 A	3 Pole	4221 08	43904	1
	500 A	3 Pole	4221 09	47480	1
	630 A	3 Pole	4221 10	52790	1
	320 A	4 Pole	4221 12	52640	1
	400 A	4 Pole	4221 13	52640	1
	500 A	4 Pole	4221 14	59562	1
	630 A	4 Pole	4221 15	59562	1
DPX ³ 630 Ⓢ Icu = 70 kA	320 A	3 Pole	4221 17	52244	1
	400 A	3 Pole	4221 18	52244	1
	500 A	3 Pole	4221 19	55352	1
	630 A	3 Pole	4221 20	55352	1
	320 A	4 Pole	4221 22	61804	1
	400 A	4 Pole	4221 23	61804	1
	500 A	4 Pole	4221 24	67740	1
	630 A	4 Pole	4221 25	67740	1
DPX ³ 630 Ⓢ Icu = 100 kA	320 A	3 Pole	4221 27	■	1
	400 A	3 Pole	4221 28	■	1
	500 A	3 Pole	4221 29	■	1
	630 A	3 Pole	4221 30	■	1
	320 A	4 Pole	4221 32	■	1
	400 A	4 Pole	4221 33	■	1
	500 A	4 Pole	4221 34	■	1
	630 A	4 Pole	4221 35	■	1

MCCBs electronic release Sg

DPX ³ 630 Ⓢ Icu = 36 kA	320 A	3 Pole	4221 37	40320	1
	400 A	3 Pole	4221 38	40320	1
	500 A	3 Pole	4221 39	43446	1
	630 A	3 Pole	4221 40	43446	1
	320 A	4 Pole	4221 42	47146	1
	400 A	4 Pole	4221 43	47146	1
	500 A	4 Pole	4221 44	54838	1
	630 A	4 Pole	4221 45	54838	1



4221 38



4221 43

■ Price available on request.

*LP-List Price Inclusive of excise duty but exclusive of sales tax or any other taxes.

Red Cat.Nos - new products

DPX³ 630

S2 electronic release MCCBs from 250 to 630 A

NEW!

Type and frame sizes	Amps.	Poles	Cat.Nos	LP* ₹ / Unit	Pack
----------------------	-------	-------	---------	-----------------	------

MCCBs electronic release Sg

DPX ³ 630 Ⓢ Icu = 50 kA	320 A	3 Pole	4221 47	41888	1
	400 A	3 Pole	4221 48	41888	1
	500 A	3 Pole	4221 49	47274	1
	630 A	3 Pole	4221 50	47274	1
	320 A	4 Pole	4221 52	50986	1
	400 A	4 Pole	4221 53	50986	1
	500 A	4 Pole	4221 54	61110	1
	630 A	4 Pole	4221 55	61110	1
DPX ³ 630 Ⓢ Icu = 70 kA	320 A	3 Pole	4221 57	49002	1
	400 A	3 Pole	4221 58	49002	1
	500 A	3 Pole	4221 59	56096	1
	630 A	3 Pole	4221 60	56096	1
	320 A	4 Pole	4221 62	60726	1
	400 A	4 Pole	4221 63	60726	1
	500 A	4 Pole	4221 64	76330	1
	630 A	4 Pole	4221 65	76330	1
DPX ³ 630 Ⓢ Icu = 100 kA	320 A	3 Pole	4221 67	■	1
	400 A	3 Pole	4221 68	■	1
	500 A	3 Pole	4221 69	■	1
	630 A	3 Pole	4221 70	■	1
	320 A	4 Pole	4221 72	■	1
	400 A	4 Pole	4221 73	■	1
	500 A	4 Pole	4221 74	■	1
	630 A	4 Pole	4221 75	■	1

MCCBs electronic release Sg with energy metering central unit

DPX ³ 630 Ⓢ Icu = 36 kA	320 A	3 Pole	4221 77	53320	1
	400 A	3 Pole	4221 78	53320	1
	500 A	3 Pole	4221 79	56446	1
	630 A	3 Pole	4221 80	56446	1
	320 A	4 Pole	4221 82	61146	1
	400 A	4 Pole	4221 83	61146	1
	500 A	4 Pole	4221 84	68838	1
	630 A	4 Pole	4221 85	68838	1
DPX ³ 630 Ⓢ Icu = 50 kA	320 A	3 Pole	4221 87	55888	1
	400 A	3 Pole	4221 88	55888	1
	500 A	3 Pole	4221 89	61274	1
	630 A	3 Pole	4221 90	61274	1
	320 A	4 Pole	4221 92	64986	1
	400 A	4 Pole	4221 93	64986	1
	500 A	4 Pole	4221 94	75110	1
	630 A	4 Pole	4221 95	75110	1



4221 85

Bold Cat.Nos are products normally available with Legrand (India) Stockists. Cat.Nos that are not bold - delivery within 4 - 8 weeks from the date of order. Bold packing quantity is our mandatory packing. Orders to be placed by Legrand (India) Stockist in multiples of the same.

DPX³ 630

S2 electronic release MCCBs from 250 to 630 A

Type and frame sizes	Amps.	Poles	Cat.Nos	LP* ₹ / Unit	Pack
----------------------	-------	-------	---------	-----------------	------

NEW!

MCCBs electronic release Sg with energy metering central unit

DPX ³ 630 Ⓢ Icu = 70 kA	320 A	3 Pole	4221 97	63002	1
	400 A	3 Pole	4221 98	63002	1
	500 A	3 Pole	4221 99	70096	1
	630 A	3 Pole	4222 00	70096	1
	320 A	4 Pole	4222 02	74726	1
	400 A	4 Pole	4222 03	74726	1
	500 A	4 Pole	4222 04	90330	1
	630 A	4 Pole	4222 05	90330	1
DPX ³ 630 Ⓢ Icu = 100 kA	320 A	3 Pole	4222 07	■	1
	400 A	3 Pole	4222 08	■	1
	500 A	3 Pole	4222 09	■	1
	630 A	3 Pole	4222 10	■	1
	320 A	4 Pole	4222 12	■	1
	400 A	4 Pole	4222 13	■	1
	500 A	4 Pole	4222 14	■	1
	630 A	4 Pole	4222 15	■	1

DPX³ 630

earth leakage modules

Earth leakage modules

Standard

DPX ³ 630 Ⓢ	400 A	3 Pole	0260 60	62856	1
	630 A	3 Pole	0260 64	64180	1
	400 A	4 Pole	0260 61	58098	1
	630 A	4 Pole	0260 65	57062	1

LED version

DPX ³ 630 Ⓢ	400 A	4 Pole	0260 63	79676	1
	630 A	4 Pole	0260 67	82440	1



0260 63

NEW!

DPX³ 1600

thermal magnetic release

MCCBs from 630 to 1250 A

MCCBs thermal magnetic release

DPX ³ 1600 Ⓢ Icu = 36 kA	800 A	3 Pole	4222 52	48000	1
	1000 A	3 Pole	4222 53	58000	1
	1250 A	3 Pole	4222 54	78000	1
	800 A	4 Pole	4222 57	56000	1
	1000 A	4 Pole	4222 58	69000	1
	1250 A	4 Pole	4222 59	83000	1
	DPX ³ 1600 Ⓢ Icu = 50 kA	800 A	3 Pole	4222 64	50632
1000 A		3 Pole	4222 65	70926	1
1250 A		3 Pole	4222 66	98128	1
	800 A	4 Pole	4222 69	63740	1
	1000 A	4 Pole	4222 70	100420	1
	1250 A	4 Pole	4222 71	109964	1

NEW!

DPX³ 1600 - thermal magnetic release

MCCBs from 630 to 1250 A

Type and frame sizes	Amps.	Poles	Cat.Nos	LP* ₹ / Unit	Pack
----------------------	-------	-------	---------	-----------------	------

MCCBs thermal magnetic release

DPX ³ 1600 Ⓢ Icu = 70 kA	800 A	3 Pole	4222 76	64830	1
	1000 A	3 Pole	4222 77	98172	1
	1250 A	3 Pole	4222 78	104596	1
	800 A	4 Pole	4222 81	80264	1
	1000 A	4 Pole	4222 82	139000	1
	1250 A	4 Pole	4222 83	160284	1
DPX ³ 1600 Ⓢ Icu = 100 kA	800 A	3 Pole	4222 88	■	1
	1000 A	3 Pole	4222 89	■	1
	1250 A	3 Pole	4222 90	■	1
	800 A	4 Pole	4222 93	■	1
	1000 A	4 Pole	4222 94	■	1
	1250 A	4 Pole	4222 95	■	1



4222 78



4222 83

DPX³ 1600

S2 electronic release

MCCBs from 630 to 1600 A

MCCBs electronic release S2

DPX ³ 1600 Ⓢ Icu = 36 kA	800 A	3 Pole	4223 00	53600	1
	1000 A	3 Pole	4223 01	81300	1
	1250 A	3 Pole	4223 02	98000	1
	1600 A	3 Pole	4223 03	108900	1
	800 A	4 Pole	4223 06	62000	1
	1000 A	4 Pole	4223 07	120000	1
	1250 A	4 Pole	4223 08	138000	1
	1600 A	4 Pole	4223 09	154000	1
DPX ³ 1600 Ⓢ Icu = 50 kA	800 A	3 Pole	4223 12	61400	1
	1000 A	3 Pole	4223 13	80000	1
	1250 A	3 Pole	4223 14	98000	1
	1600 A	3 Pole	4223 15	124000	1
	800 A	4 Pole	4223 18	78300	1
	1000 A	4 Pole	4223 19	118000	1
	1250 A	4 Pole	4223 20	150266	1
	1600 A	4 Pole	4223 21	174500	1
	DPX ³ 1600 Ⓢ Icu = 70 kA	800 A	3 Pole	4223 24	72000
1000 A		3 Pole	4223 25	100900	1
1250 A		3 Pole	4223 26	122000	1
	1600 A	3 Pole	4223 27	164000	1
	800 A	4 Pole	4223 30	92000	1
	1000 A	4 Pole	4223 31	144000	1
	1250 A	4 Pole	4223 32	168000	1
	1600 A	4 Pole	4223 33	210000	1
	DPX ³ 1600 Ⓢ Icu = 100 kA	800 A	3 Pole	4223 36	■
1000 A		3 Pole	4223 37	■	1
1250 A		3 Pole	4223 38	■	1
	800 A	4 Pole	4223 42	■	1
	1000 A	4 Pole	4223 43	■	1
	1250 A	4 Pole	4223 44	■	1



4223 27



4223 33

■ Price available on request.

*LP - List Price Inclusive of excise duty but exclusive of sales tax or any other taxes.

Red Cat.Nos - new products

Bold Cat.Nos are products normally available with Legrand (India) Stockists. Cat.Nos that are not bold - delivery within 4 - 8 weeks from the date of order. Bold packing quantity is our mandatory packing. Orders to be placed by Legrand (India) Stockist in multiples of the same.

NEW!

DPX³ 1600

S2 electronic release MCCBs from 630 to 1600 A

Type and frame sizes	Amps.	Poles	Cat.Nos	LP* ₹ / Unit	Pack
----------------------	-------	-------	---------	-----------------	------

MCCBs electronic release S2 with energy metering central unit

DPX ³ 1600 Icu = 36 kA	800 A	3 Pole	4223 48	68600	1
	1000 A	3 Pole	4223 49	96300	1
	1250 A	3 Pole	4223 50	113000	1
	1600 A	3 Pole	4223 51	123900	1

800 A	4 Pole	4223 54	77000	1	
	1000 A	4 Pole	4223 55	135000	1
	1250 A	4 Pole	4223 56	153000	1
	1600 A	4 Pole	4223 57	169000	1

DPX ³ 1600 Icu = 50 kA	800 A	3 Pole	4223 60	72400	1
	1000 A	3 Pole	4223 61	91000	1
	1250 A	3 Pole	4223 62	109000	1
	1600 A	3 Pole	4223 63	135000	1

800 A	4 Pole	4223 66	89300	1	
	1000 A	4 Pole	4223 67	129000	1
	1250 A	4 Pole	4223 68	161266	1
	1600 A	4 Pole	4223 69	185500	1

DPX ³ 1600 Icu = 70 kA	800 A	3 Pole	4223 72	83000	1
	1000 A	3 Pole	4223 73	111900	1
	1250 A	3 Pole	4223 74	133000	1
	1600 A	3 Pole	4223 75	175000	1

800 A	4 Pole	4223 78	103000	1	
	1000 A	4 Pole	4223 79	155000	1
	1250 A	4 Pole	4223 80	179000	1
	1600 A	4 Pole	4223 81	221000	1

DPX ³ 1600 Icu = 100 kA	800 A	3 Pole	4223 84	■	1
	1000 A	3 Pole	4223 85	■	1
	1250 A	3 Pole	4223 86	■	1

800 A	4 Pole	4223 90	■	1	
	1000 A	4 Pole	4223 91	■	1
	1250 A	4 Pole	4223 92	■	1

DPX³ 1600

Sg electronic release MCCBs from 630 to 1600 A

MCCBs electronic release Sg

DPX ³ 1600 Icu = 36 kA	800 A	3 Pole	4223 96	78560	1
	1000 A	3 Pole	4223 97	104500	1
	1250 A	3 Pole	4223 98	114600	1
	1600 A	3 Pole	4223 99	122300	1

800 A	4 Pole	4224 02	94000	1	
	1000 A	4 Pole	4224 03	142000	1
	1250 A	4 Pole	4224 04	160000	1
	1600 A	4 Pole	4224 05	188000	1

■ Price available on request.

*LP -List Price Inclusive of excise duty but exclusive of sales tax or any other taxes.

Red Cat.Nos - new products



4223 51



4223 54

NEW!

DPX³ 1600

Sg electronic release MCCBs from 630 to 1600 A

Type and frame sizes	Amps.	Poles	Cat.Nos	LP* ₹ / Unit	Pack
----------------------	-------	-------	---------	-----------------	------

MCCBs electronic release Sg

DPX ³ 1600 Icu = 50 kA	800 A	3 Pole	4224 08	69536	1
	1000 A	3 Pole	4224 09	88960	1
	1250 A	3 Pole	4224 10	132000	1
	1600 A	3 Pole	4224 11	158000	1

800 A	4 Pole	4224 14	90000	1	
	1000 A	4 Pole	4224 15	140000	1
	1250 A	4 Pole	4224 16	174000	1
	1600 A	4 Pole	4224 17	204500	1

DPX ³ 1600 Icu = 70 kA	800 A	3 Pole	4224 20	77792	1
	1000 A	3 Pole	4224 21	130000	1
	1250 A	3 Pole	4224 22	151300	1
	1600 A	3 Pole	4224 23	204300	1

800 A	4 Pole	4224 26	104500	1	
	1000 A	4 Pole	4224 27	176420	1
	1250 A	4 Pole	4224 28	204230	1
	1600 A	4 Pole	4224 29	240760	1

DPX ³ 1600 Icu = 100 kA	800 A	3 Pole	4224 32	■	1
	1000 A	3 Pole	4224 33	■	1
	1250 A	3 Pole	4224 34	■	1

800 A	4 Pole	4224 38	■	1	
	1000 A	4 Pole	4224 39	■	1
	1250 A	4 Pole	4224 40	■	1

MCCBs electronic release Sg with energy metering central unit

DPX ³ 1600 Icu = 36 kA	800 A	3 Pole	4224 44	93560	1
	1000 A	3 Pole	4224 45	119500	1
	1250 A	3 Pole	4224 46	129600	1
	1600 A	3 Pole	4224 47	137300	1

800 A	4 Pole	4224 50	109000	1	
	1000 A	4 Pole	4224 51	157000	1
	1250 A	4 Pole	4224 52	175000	1
	1600 A	4 Pole	4224 53	203000	1

DPX ³ 1600 Icu = 50 kA	800 A	3 Pole	4224 56	84536	1
	1000 A	3 Pole	4224 57	100960	1
	1250 A	3 Pole	4224 58	144000	1
	1600 A	3 Pole	4224 59	170000	1

800 A	4 Pole	4224 62	102000	1	
	1000 A	4 Pole	4224 63	152000	1
	1250 A	4 Pole	4224 64	186000	1
	1600 A	4 Pole	4224 65	216500	1



4224 23



4224 29



4224 47



4224 65

Bold Cat.Nos are products normally available with Legrand (India) Stockists. Cat.Nos that are not bold - delivery within 4 - 8 weeks from the date of order. Bold packing quantity is our mandatory packing. Orders to be placed by Legrand (India) Stockist in multiples of the same.

DPX³ 1600

Sg electronic release MCCBs from 630 to 1600 A

Type and frame sizes	Amps.	Poles	Cat.Nos	LP* ₹ / Unit	Pack
----------------------	-------	-------	---------	-----------------	------

NEW!

MCCBs electronic release Sg with energy metering central unit

DPX ³ 1600 Icu = 70 kA	800 A	3 Pole	4224 68	89792	1
	1000 A	3 Pole	4224 69	142000	1
	1250 A	3 Pole	4224 70	163300	1
	1600 A	3 Pole	4224 71	216300	1
	800 A	4 Pole	4224 74	116500	1
DPX ³ 1600 Icu = 100 kA	1000 A	4 Pole	4224 75	188420	1
	1250 A	4 Pole	4224 76	216230	1
	1600 A	4 Pole	4224 77	252760	1
	800 A	4 Pole	4224 80	■	1
	1000 A	4 Pole	4224 81	■	1
DPX ³ 1600 Icu = 100 kA	1250 A	4 Pole	4224 82	■	1
	800 A	4 Pole	4224 86	■	1
	1000 A	4 Pole	4224 87	■	1
	1250 A	4 Pole	4224 88	■	1

DPX³/DPX magnetic only
motor protection MCCBs up to 400 A

DPX³ 160

DPX ³ 160 Icu = 16kA	16 A	3 Pole	4207 10	10328	1
	25 A	3 Pole	4207 11	10328	1
	50 A	3 Pole	4207 12	10328	1
	63 A	3 Pole	4207 13	10328	1
DPX ³ 160 Icu = 25kA	16 A	3 Pole	4207 14	11474	1
	25 A	3 Pole	4207 15	11474	1
	50 A	3 Pole	4207 16	11474	1
	63 A	3 Pole	4207 17	11474	1

DPX³ 250

DPX ³ 250 Icu = 36 kA	100 A	3 Pole	420718	20652	1
	160 A	3 Pole	420719	20652	1
	200 A	3 Pole	420720	21800	1
	250 A	3 Pole	420721	22946	1
DPX ³ 250 Icu = 25 kA	100 A	3 Pole	4207 22	18356	1
	160 A	3 Pole	4207 23	18356	1
	200 A	3 Pole	4207 24	19506	1
	250 A	3 Pole	4207 25	20652	1

DPX³-I trip-free switches
160 to 1600 A

Trip free switches

DPX ³ -I 160 ①	160 A	3 Pole	4201 98	10846	1
	160 A	4 Pole	4201 99	13614	1
	160 A	4 Pole with elm	4201 97	39998	1

■ Price available on request.

*LP - List Price Inclusive of excise duty but exclusive of sales tax or any other taxes.

Red Cat.Nos - new products

DPX³-I trip-free switches
160 to 1600 A

Type and frame sizes	Amps.	Poles	Cat.Nos	LP* ₹ / Unit	Pack
----------------------	-------	-------	---------	-----------------	------

Trip free switches

DPX ³ -I 250 ②	250 A	3 Pole	4202 99	23132	1
	250 A	4 Pole	4203 00	28070	1
	250 A	4 Pole with elm	4202 98	68672	1
	400 A	4 Pole	4222 18	43800	1
DPX ³ -I 630 ③	400 A	3 Pole	4222 16	34800	1
	630 A	3 Pole	4222 17	39000	1
	630 A	4 Pole	4222 19	58000	1
	1250 A	4 Pole	4224 96	84000	1
DPX ³ -I 1600 ④	630 A	3 Pole	4224 90	42200	1
	800 A	3 Pole	4224 91	54000	1
	1250 A	3 Pole	4224 92	64300	1
	1600 A	3 Pole	4224 93	84000	1
	630 A	4 Pole	4224 94	52000	1
	800 A	4 Pole	4224 95	68000	1
	1250 A	4 Pole	4224 96	84000	1
	1600 A	4 Pole	4224 97	118000	1



4202 99



4210 40

DPX³ 160

equipment and mounting accessories

Cat.Nos	Description	LP* ₹ / Unit	Pack
---------	-------------	-----------------	------

Equipment for plug-in version

4210 40	For DPX ³ 160 - 3 P	25846	1
4210 41	For DPX ³ 160 - 4 P with or without earth leakage module	34646	1
4210 44	Set of connectors for auxiliary contacts	10286	1
4210 45	Key barrel and flat key for Padlocks	22938	1
4210 46	Key barrel and star key for Padlocks	20772	1
4210 47	Padlock accessory	6376	1

Connection accessories

4210 26	Set of 3 terminals for High capacity cage terminals	5464	1
4210 27	Set of 4 terminals for High capacity cage terminals	7222	1
4210 70	Set of 3 insulated shields	120	1
4210 28	Set of 3 terminals Screw terminals for copper bars connection	626	1
4210 29	Set of 4 terminals Screw terminals for copper bars connection	750	1
6250 02	Set of 3 spreaders for DPX ³ 160 3P	334	1
6250 06	Set of 4 spreaders for DPX ³ 160 4P	746	1

Bold Cat.Nos are products normally available with Legrand (India) Stockists. Cat.Nos that are not bold - delivery within 4 - 8 weeks from the date of order. Bold packing quantity is our mandatory packing. Orders to be placed by Legrand (India) Stockist in multiples of the same.

DPX³ 160 equipment and mounting accessories



4210 36

Cat.Nos	Description	LP* ₹ / Unit	Pack
---------	-------------	--------------------	------

Connection accessories

4210 36	Set of 3 rear terminals for DPX ³ 160 3 P	5162	1
4210 37	Set of 4 rear terminals for DPX ³ 160 4 P	6860	1

Sealable terminal shields

For front terminals

4210 54	For DPX ³ 160 3 P	5638	1
4210 55	For DPX ³ 160 3 P	5898	1

For rear terminals

4210 50	For DPX ³ 160 3 P	3530	1
4210 51	For DPX ³ 160 4 P	3136	1

Fixing plates

4210 71	For DPX ³ 160 3P/4P without earth leakage module	294	1
4210 73	For DPX ³ 160 4 P with earth leakage module	714	1
4210 68	For DPX ³ 160 3P/4P with side mounting motor operator	1300	1

DPX³ 160 and 250 common auxiliaries and accessories

Supply inverter type

4210 58	For fixed version	4758	1
4210 59	For plug-in and draw-out version	5024	1

Rotary handles

6210 00	Standard handle for thermal magnetic DPX ³ without earth leakage module	1356	1
6210 01	Standard handle for electronic DPX ³ and/or with earth leakage module	1626	1
6210 04	Vari-depth standard handles	2060	1
4210 06	Ronis for direct handle	6694	1
4210 07	Profalux for direct handle	7300	1
4210 08	Ronis for vari-depth handle	4260	1
4210 09	Profalux for vari-depth handle	9124	1

Motor-driven handles

4210 60	Side motor operator	24174	1
4210 61	Front motor operator	21714	1
4210 62	Ronis key barrel for front motor operator	8682	1
4210 63	Profalux key barrel for front motor operator	20426	1
4210 64	Padlock for front motor operator	2914	1
4210 65	Ronis key barrel for side motor operator	22680	1
4210 66	Profalux key barrel for side motor operator	20610	1
4210 67	Padlock for side motor operator	3096	1

*LP-List Price Inclusive of excise duty but exclusive of sales tax or any other taxes.

DPX³ 160 and 250 common auxiliaries and accessories



4210 10



4210 11



4210 16



4210 22

Cat.Nos	Description	LP* ₹ / Unit	Pack
---------	-------------	--------------------	------

Auxiliary contacts

4210 10	1 N/C + 1 N/O auxiliary contact for rotary handles	1218	1
4210 11	Auxiliary contact or fault signalling contact	950	1
4210 48	Signalling contact plugged-in/drawn-out (for DPX ³ plug-in version)	4104	1

Shunt releases

4210 12	12 V \sim /=	2250	1
4210 13	24 V \sim /=	2250	1
4210 14	48 V \sim /=	2250	1
4210 15	110-130 V \sim /=	2250	1
4210 16	200-277 V \sim /=	2250	1
4210 17	380-480 V \sim /=	2250	1

Undervoltage releases

4210 18	12 V \sim /=	2532	1
4210 19	24 V \sim /=	2532	1
4210 20	48 V \sim /=	2532	1
4210 21	110-130 V \sim /=	2532	1
4210 22	200-240 V \sim /=	2532	1
4210 23	277 V \sim	2532	1
4210 24	380-415 V \sim	2532	1
4210 25	440-480 V \sim	2532	1

Locking accessory

4210 49	Padlock for locking in "open" position	1482	1
---------	--	------	---

Communication interface

4210 75	Modbus	18350	1
---------	--------	-------	---

DPX³ 250 equipment and mounting accessories

Equipment for plug-in version

4210 42	For DPX ³ 250 - 3 P	28946	1
4210 43	For DPX ³ 250 - 4 P with or without earth leakage module	34864	1
4210 44	Set of connectors for auxiliary contacts	10286	1
4210 45	Key barrel and flat key N° ABA90GEL6149 for Padlocks	22938	1
4210 46	Key barrel and star key N° HBA90GPS6149 for Padlocks	20772	1
4210 47	Padlock accessory	6376	1

Connection accessories

4210 30	Set of 3 cage terminals	2222	1
4210 31	Set of 4 cage terminals	2894	1
4210 70	Set of 3 insulated shields	120	1
6250 14	Set of 3 spreaders for DPX³ 250 3 P	580	1
6250 18	Set of 4 spreaders for DPX³ 250 4 P	870	1
4210 38	Set of 3 rear terminals for DPX ³ 250 3 P	4828	1
4210 39	Set of 4 rear terminals for DPX ³ 250 4 P	6498	1



4210 31

Bold Cat.Nos are products normally available with Legrand (India) Stockists. Cat.Nos that are not bold - delivery within 4 - 8 weeks from the date of order. Bold packing quantity is our mandatory packing. Orders to be placed by Legrand (India) Stockist in multiples of the same.

DPX³ 250 equipment and mounting accessories

Cat.Nos	Description	LP* ₹ / Unit	Pack
---------	-------------	--------------------	------

Sealable terminal shields

For front terminals

4210 56	For DPX ³ 250 3 P	5948	1
4210 57	For DPX ³ 250 4 P	6296	1

For rear terminals

4210 52	For DPX ³ 250 3 P	3546	1
4210 53	For DPX ³ 250 4 P	3898	1

Fixing plates

4210 72	For DPX ³ 250 3 P/4 P without earth leakage module	294	1
4210 74	For DPX ³ 250 4 P with earth leakage module	1232	1
4210 69	For DPX ³ 250 3 P/4 P with side mounting motor operator	1314	1



4210 72

NEW! DPX³ 630 equipment and accessories

Plug-in version

4222 20	Set of incoming and outgoing terminals - 3 P (6 terminals for 3 P DPX ³ or 8 terminals for 4P DPX ³)	■	1
4222 21	Set of incoming and outgoing terminals - 4 P (6 terminals for 3 P DPX ³ or 8 terminals for 4 P DPX ³)	■	1
4222 22	Front terminal mounting base for DPX ³ only - 3 P	■	1
4222 24	Flat rear terminal mounting base for DPX ³ only - 3 P	■	1
4222 23	Front terminal mounting base for DPX ³ only - 4 P	■	1
4222 25	Flat rear terminal mounting base for DPX ³ only - 4 P	■	1
4222 26	Front terminal mounting base for DPX ³ with earth leakage module - 4 P	■	1
4222 27	Flat rear terminal mounting base for DPX ³ with earth leakage module - 4 P	■	1
4222 37	For fixing the signalling contact - 4 P Cat.No 0265 74 on a DPX ³ plug-in version	■	1
4222 28	Set of 2 extractor handle	■	1
4222 29	Set of connectors (24-pin)	■	1

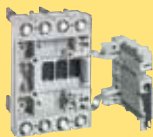

4222 25

Draw-out version

4222 31	"Debro-lift" mechanism for DPX ³ base only - 3 P	■	1
4222 32	"Debro-lift" mechanism for DPX ³ base only - 4 P	■	1
4222 33	"Debro-lift" mechanism for DPX ³ base with elm - 4 P	■	1
0265 76	One key for "Debro-lift" mechanism for DPX ³ only - Flat key	■	1
0265 78	Two keys (one key supplied) for "Debro-lift" mechanism for motorised DPX ³ or with rotary handle - Flat key	■	1



4222 32

■ Price available on request.

*LP-List Price Inclusive of excise duty but exclusive of sales tax or any other taxes.

Red Cat.Nos - new products

DPX³ 630 equipment and accessories

NEW!

Cat.Nos	Description	LP* ₹ / Unit	Pack
---------	-------------	--------------------	------

Draw-out version

0263 48	One key for "Debro-lift" mechanism for DPX ³ only - Star key	■	1
0265 77	Two keys (one key supplied) for motorised DPX ³ or with rotary handle - Star key	■	1
0265 75	Handle for drawing-out for "Debro-lift" mechanism	■	1
0265 74	Signalling contact (plugged-in/drawn-out) for "Debro-lift" mechanism	■	1
4222 36	For fixing the signalling contact Cat.No 0265 74 on a DPX ³ draw-out version	■	1
4222 30	Block of 6 automatic auxiliary contacts for DPX ³ draw-out version (up to 2 blocks by DPX ³)	■	1

Supply inverter type

0264 09	Plate for MCCB or trip-free switch fixed version	6962	1
0264 04	Plate for MCCB or trip-free switch plug-in and draw-out version	14428	1

Rotary handles

0262 41	Standard (grey) direct on DPX ³	2208	1
0262 81	Standard (grey) vari-depth handle IP 55	3798	1
0262 93	Key barrel and flat key for vary-depth handle	11694	1
0262 94	Key barrel and star key for vary-depth handle	9094	1

Motor-driven handles

0261 40	Front operated 24 V~	37050	1
0261 41	Front operated 48 V~	37050	1
0261 44	Front operated 230 V~	34692	1
0261 59	Lock and flat key	11694	1
0261 58	Lock and star key	12742	1



0261 40

Accessories

0262 30	Set of 3 Insulated shields	146	1
0262 44	Set of 2 sealable terminal shields - 3 P	4334	1
0262 45	Set of 2 sealable terminal shields - 4 P	4294	1
0262 40	Padlock for locking in "OPEN" position - 4 P	1460	1
0262 46	Set of 4 adaptors + insulated shields for lug - 4 P	6308	1
0262 47	Set of 4 extended front terminals - 4 P	9110	1
6250 04	Set of incoming or outgoing spreaders - 3 P	2266	1
6250 08	Set of incoming or outgoing spreaders - 4 P	3078	1
0263 50	Set of incoming or outgoing swivel rear terminals - 3 P	25230	1
0263 52	Set of incoming or outgoing flat rear terminals - 3 P	30200	1
0263 51	Set of incoming or outgoing swivel terminals - 4 P	33386	1
0263 53	Set of incoming or outgoing flat terminals - 4 P	37950	1
4222 34	Set of 2 IP 20 terminal covers - 3 P	800	1
4222 35	Set of 2 IP 20 terminal covers - 4 P	1200	1



4222 34



4222 35



6250 04

Bold Cat.Nos are products normally available with Legrand (India) Stockists. Cat.Nos that are not bold - delivery within 4 - 8 weeks from the date of order. Bold packing quantity is our mandatory packing. Orders to be placed by Legrand (India) Stockist in multiples of the same.

DPX³ 1600 equipment and accessories



4225 88
+
4225 93

Cat.Nos	Description	LP* ₹ / Unit	Pack
Draw-out version			
4225 86	Front terminals - 3 P	■	1
4225 88	Rear terminals - 3 P	■	1
4225 87	Front terminals - 4 P	■	1
4225 89	Rear terminals - 4 P	■	1
4225 93	Debro-lift mechanism For DPX ³ 1600 - 3 P	■	1
4225 94	Debro-lift mechanism for DPX ³ 1600 - 4 P	■	1
4225 95	For fixing the signalling contact Cat.No 0265 74 on a DPX ³ draw-out version	■	1
0265 76	One key for "Debro-lift" mechanism for DPX ³ only - Flat key	■	1
0265 80	Two key (one key supplied) for motorised DPX ³ or with rotary handle	■	1
0263 48	One key for DPX ³ only - Starkey	■	1
0265 79	Two key (one key supplied) for motorised DPX ³ or with rotary handle	■	1
0265 75	Handle for drawing-out for "Debro-lift" mechanism	■	1
0265 74	Signalling contact (plugged-in/drawn-out)	■	1
4222 30	Block of 6 automatic auxiliary contacts for DPX ³ draw-out version (up to 2 blocks by DPX ³)	■	1

Supply inverter type

0264 10	Plate for MCCBs or trip-free switch fixed version	8802	1
0264 05	Plate for MCCBs or trip-free switch plug-in and draw-out version	15604	1

Rotary handles

0262 61	Standard (black) direct on DPX ³	2838	1
0262 83	Standard (black) vari-depth handle IP 55	5392	1
0262 93	Key barrel and flat key	11694	1
0262 94	Key barrel and star key	9094	1

Motor-driven handles

0261 54	Front operated 230 V~	60916	1
0261 24	Front operated 24 V~/=	70600	1
	for In ≤ 1250 A		
0261 25	Front operated 48 V~/=	60916	1
	for In ≤ 1250 A		

■ Price available on request.

*LP-List Price Inclusive of excise duty but exclusive of sales tax
or any other taxes.

Red Cat.Nos - new products

DPX³ 1600 equipment and accessories

Cat.Nos	Description	LP* ₹ / Unit	Pack
Motor-driven handles			
0261 26	Front operated 110 V~/=	60916	1
	for In ≤ 1250 A		
0261 23	Front operated 230 V~/=	57040	1
	for In ≤ 1250 A		
0261 19	Front operated 24 V~/=	71340	1
	for In = 1600 A		
0261 28	Front operated 48 V~/=	61498	1
	for In = 1600 A		
0261 29	Front operated 110 V~/=	61498	1
	for In = 1600 A		
0261 27	Front operated 230 V~/=	57586	1
	for In = 1600 A		
0261 59	Key and flat key	11694	1
0261 58	Key and star key	12742	1

Accessories

0262 66	Set of 3 insulated shields	280	1
0262 64	Set of 2 sealable terminal shields - 3 P	7136	1
0262 65	Set of 2 sealable terminal shields - 4 P	7390	1
0262 60	Padlock for locking in "open" position	1690	1
0262 67	Set of 4 extended front short terminals for 630 - 1250 A (2 bars max. per pole)	8664	1
0262 68	Set of 4 extended front Long terminals for 1600 A (3 bars max. per pole)	16184	1
0262 73	Set of incoming or outgoing spreaders 3 P	■	1
0262 74	Set of incoming or outgoing spreaders 4 P	■	1
0263 80	Short rear terminals 3 P	38990	1
0263 81	Long rear terminals 3 P	87924	1
0263 82	Short rear terminals 4 P	50584	1
0263 83	Long rear terminals 4 P	115766	1
4225 90	Set of 2 IP 20 terminal covers 3 P	1200	1
4225 91	Set of 2 IP 20 terminal covers 4 P	1800	1
4225 92	External neutral 4 P	■	1



0262 60



0262 67
+
0262 68

Bold Cat.Nos are products normally available with Legrand (India) Stockists.
Cat.Nos that are not bold - delivery within 4 - 8 weeks from the date of order.
Bold packing quantity is our mandatory packing. Orders to be placed by
Legrand (India) Stockist in multiples of the same.

DPX³ 630 and 1600 common auxiliaries



0261 93

Cat.Nos	Description	LP* ₹ / Unit	Pack
Automation control unit			
0261 93	Standard unit	66570	1
0261 94	Communicating unit, enabling data transmission	71534	1

DPX³ 160, 250, 630 and 1600 power supervision system

Auxiliary power supply for DPX³

4210 83	Input voltage 24 V \sim / \equiv 2 modules	■	1
---------	---	---	---

RS485 Modbus communication interface

4210 75	DPX ³ electronic interface for connecting thermal- magnetic DPX ³ with residual current protection and electronic DPX ³ to an RS485 Modbus	■	1
---------	--	---	---

Modular power supply

0035 67	230 V \sim - 27 V \equiv - 0.6 A 2 modules	■	1
---------	---	---	---

Communication and supervision

0261 78	Web servers for 32 metering points (meters or multi-function measuring units)	■	1
0261 79	Web servers for an unlimited number of metering points (meters or multi-function measuring units)	■	1
0261 88	Legrand Software For 32 metering points (supplied on CD)	■	1
0261 89	Legrand Software For an unlimited number of metering points (supplied on CD)	■	1

Panel board display

0261 56	Allows to chek information comming from different protection devices: DX ³ -HP, DPX ³ , DMX ³ or EMDX ³	18000	1
---------	---	-------	---

Residual current relay

0260 88	Residual current relay to clip on module 2 rail \perp	16656	1
---------	--	-------	---

Coils

0260 92	Coil Ø35 mm	10494	1
0260 93	Coil Ø80 mm	13268	1
0260 94	Coil Ø110 mm	23614	1

Bold cat. nos. are products normally available with Legrand (India) Stockists.
Cat nos. that are not bold - delivery within 4 - 8 weeks from the date of order.
Bold packing quantity is our mandatory packing. Orders to be placed by Legrand (India) Stockist in multiples of the same.

DPX³ 160, 250, 630 and 1600 power supervision system



0260 98

Cat.Nos	Description	LP* ₹ / Unit	Pack
Coils			
0260 95	Coil Ø140 mm	24842	1
0260 96	Coil Ø210 mm	42376	1
0260 97	Coil Ø150 mm - open	63712	1
0260 98	Coil Ø300 mm - open	105762	1

Residual current relay and coils

Measurement and control of electric equipment

0261 35	Central position	■	1/2
0261 37	Microprocessor interface	■	1/3
0261 36	Interface signaling and control	■	1/2
0261 45	Kit configurator	■	1/4
0466 23	Stabilized power	■	1/20



0261 37

NEW! DPX³ automatic transfer switch

DPX³ ready-to-install ATS kit without MCCBs

6253 80AA	Complete kit assembly for DPX ³ 160	■	1
6253 80AB	Complete kit assembly for DPX ³ 160 & DPX ³ 250	■	1
6253 80BB	Complete kit assembly for DPX ³ 250	■	1
6253 93	Kit assembly for ATS for DPX ³ 160	■	1
6253 94	Kit assembly for ATS for DPX ³ 250	■	1
6253 95	Kit assembly for ATS for DPX ³ 630	■	1



6253 93

CABLOFIL®

INNOVATORS IN CABLE MANAGEMENT



World leader
in wire mesh cable trays

Wide range
of wire mesh cable trays and accessories for
all types of installations

Innovation & technology
73 active patents

discover at : www.cablofil.co.in



for product enquires and prices please contact Legrand personnel

- To arrive at the complete automatic transfer switch :
 - add 2 MCCBs to the supply inverter plate
 - add motors for the MCCBs in case motorised version is required
 - add electronic control box of suitable voltage in case automatic changeover is required
 - add auxiliaries as required

■ Price available on request.

*LP -List Price Inclusive of excise duty but exclusive of sales tax or any other taxes.

Red Cat.Nos - new products
For MCCB Enclosures - refer pg. 48

Alpican™ Resin filled capacitors

NEW!

Cat.Nos	Description	LP* ₹ / Unit	Pack
---------	-------------	-----------------	------

Standard duty Resin filled capacitor 440 V, 3 phase, 50 Hz

4151 00	1 KVAR	228	1/12
4151 01	2.1 KVAR	478	1/12
4151 02	3 KVAR	684	1/12
4151 03	4.2 KVAR	950	1/12
4151 04	5 KVAR	1130	1/12
4151 05	7.5 KVAR	1520	1/6
4151 06	10 KVAR	1986	1/4
4151 07	12.5 KVAR	2582	1/4
4151 08	15 KVAR	2980	1/4
4151 09	20 KVAR	3974	1/4
4151 10	25 KVAR	4966	1/4
4151 11	30 KVAR	6192	1/4



4151 10

Heavy duty Resin filled capacitor 440 V, 3 phase

4151 12	1 KVAR	392	1/12
4151 13	2.1 KVAR	830	1/12
4151 14	3 KVAR	1184	1/6
4151 15	4.2 KVAR	1660	1/6
4151 16	5 KVAR	1938	1/6
4151 17	7.5 KVAR	2830	1/4
4151 18	10 KVAR	3738	1/4
4151 19	12.5 KVAR	4716	1/4
4151 20	15 KVAR	5606	1/4
4151 21	20 KVAR	7474	1/4
4151 22	25 KVAR	9256	1/2
4151 23	30 KVAR	11636	1/2



4151 23

Alpican™ Gas filled capacitors

Heavy duty gas filled capacitor 440 V, 3 phase, 50 Hz

4151 24	5.2 KVAR	2168	1/4
4151 25	7.3 KVAR	3044	1/4
4151 26	8.8 KVAR	3598	1/4
4151 27	10.5 KVAR	4378	1/4
4151 28	12.6 KVAR	5152	1/4
4151 29	16.8 KVAR	7226	1/4
4151 30	21 KVAR	8508	1/4
4151 31	25.2 KVAR	10210	1/4



4151 29

*LP - List Price Inclusive of excise duty but exclusive of sales tax or any other taxes.
Red Cat.Nos - new products

Alpican™ Resin filled capacitor for reactors

NEW!

Cat.Nos	Description	LP* ₹ / Unit	Pack
---------	-------------	-----------------	------

Standard duty Resin filled capacitor 525 V, 3 phase, 50 Hz

4151 32	5 KVAR	2164	1/6
4151 33	8.3 KVAR	3592	1/4
4151 34	10.4 KVAR	4496	1/4
4151 35	12.5 KVAR	5406	1/4
4151 36	17.5 KVAR	7224	1/4
4151 37	20.8 KVAR	8996	1/4
4151 38	25 KVAR	10712	1/4

Reactors and power factor controllers

Reactors 7 % duty

4151 48	Reactor 10 KVAR	12388	1
4151 49	Reactor 12.5 KVAR	16222	1
4151 50	Reactor 25 KVAR	20452	1
4151 51	Reactor 50 KVAR	33264	1
4151 52	Reactor 100 KVAR	66626	1



4151 50

Reactors 14 % duty

4151 53	Reactor 12.5 KVAR	19278	1
4151 54	Reactor 25 KVAR	32130	1
4151 55	Reactor 50 KVAR	42840	1

Power factor controller

4150 52	3 step controller	14026	1
4150 41	5 step controller	17182	1
4150 42	7 step controller	20574	1
4150 43	12 step controller	24088	1



4150 43

Power factor controller Eco

4151 95	4 step controller	13764	1
4151 96	6 step controller	12480	1
4151 97	8 step controller	14000	1
4151 98	12 step controller	16640	1

Alpican™

Guarantee

- The Company, at its discretion, will replace products if they have any manufacturing defect within 1 years for capacitor, Reactor & APFC controller.
- The above guarantee is applicable when the products are selected taken into consideration all the technical characteristics of the product published in our catalogue.
- The guarantee is only applicable when the products are installed as per the Company's instructions and not tampered in any manner.
- The guarantee states the Company's entire liability. It does not extend to cover consequential loss or damage or installation costs arising from defective products.

Bold Cat.Nos are products normally available with Legrand (India) Stockists. Cat.Nos that are not bold - delivery within 4 - 8 weeks from the date of order. Bold packing quantity is our mandatory packing. Orders to be placed by Legrand (India) Stockist in multiples of the same.

Zucchini™ Busbar Trunking System

For Industrial, commercial, residential and service sector buildings.

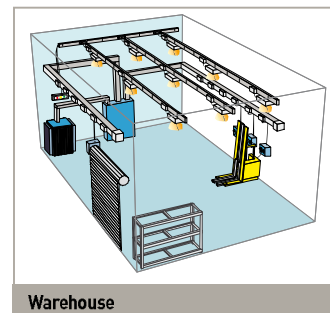
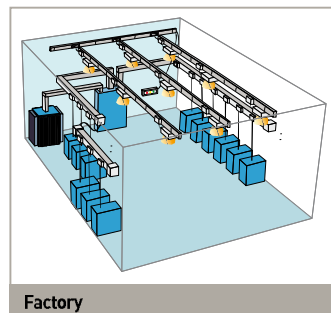
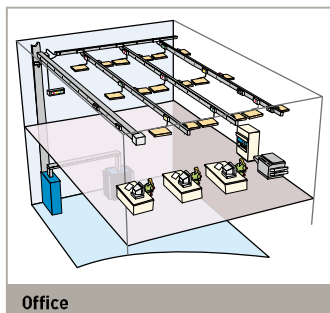
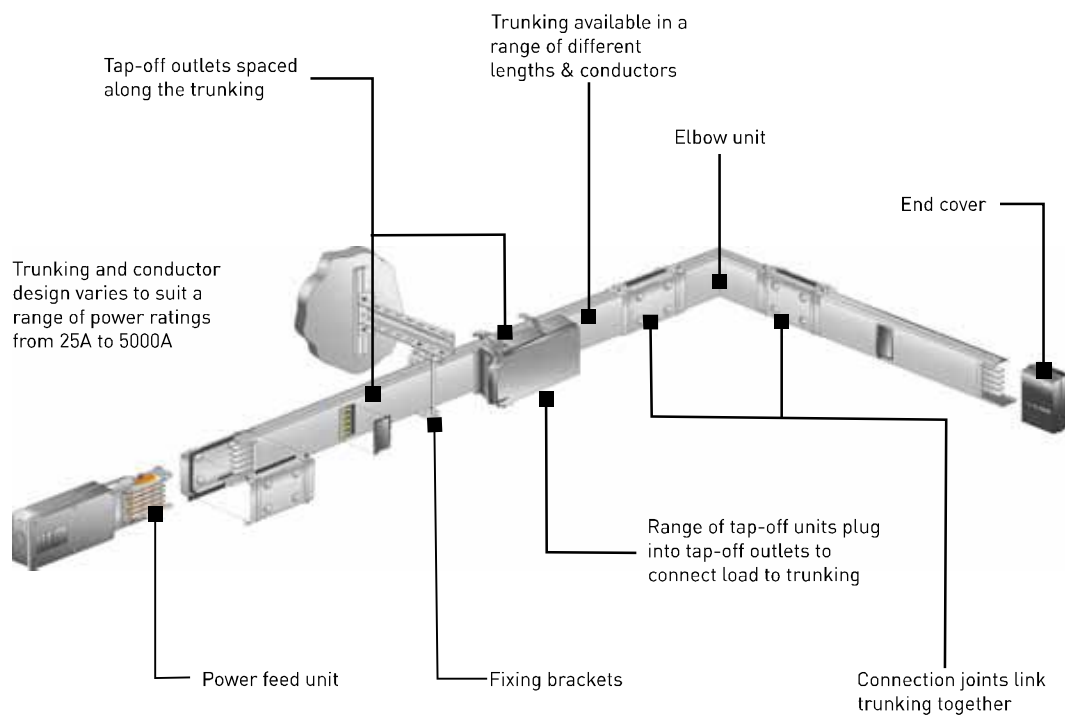

discover more on : www.zucchinispa.it

for product enquires and prices please contact Legrand personnel

A Comprehensive Range



Low Power (25 A, 40 A, 63 A)

- Lighting busway
- 2, 4 & 6 pole
- IP 55 protection
- Tap off units at each 0.5mt interval
- Copper busbars



Medium Power (63 A - 1000 A)

- Riser mains application
- IP 40, IP 52, IP 55 protection
- Tap off units at each 1mt interval
- Aluminium & copper busbars



High Power (1000 A - 5000 A)

- Air insulated type construction
- IP 30/31 protection
- Tap off boxes at each 1mt interval
- Aluminium & copper busbars



Super Compact (630 A - 5000 A)

- Sandwich type construction
- IP 56 protection
- Tap off boxes at each 1mt interval
- Aluminium & copper busbars

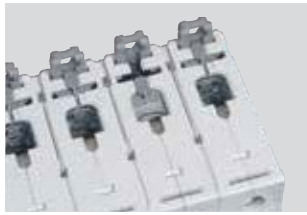

Sliding shutters



COPYTRACER
Anti-counterfeit registration number



Improved air channels



Bottom clamp



Environment friendly



DX³ The Next Step.

Presenting, DX³, an international range of protection devices. Its revolutionary design supports all kind of installations thus giving a never before experience. With 10 patents and 13 new features, it defines the next step in the protection category.

New top clamp
for all tools

Technical
labelling area



Integrated label
holder



Black handle: circuit breakers
Grey handle: switches

Breaking capacity

- 16 kA
- 25 kA
- 36 kA
- 50 kA

Colour coded
handle with
ON/OFF
colour indication



NEW!

DX³ MCBs

Cat.Nos	Nominal Rating	Number of 17.5 mm modules	MRP* ₹ / Unit	Pack
---------	----------------	---------------------------	---------------	------

MCBs for AC applications till 63 A

10 kA ISI marked as per IS/IEC 60898-1 2002
 Integrated label holder
 Sliding bottom clamp
 Improved air channels
 Color coded On/Off indication on dolly
 Biconnect lower terminals
 IP 20 protected terminals
 Sliding shutters
 DC-80 V per pole - 1 kA

C Curve

Single pole 240/410 V

4085 80	0.5	1	380	1/10/120
4085 81	1	1	380	1/10/120
4085 83	2	1	380	1/10/120
4085 84	3	1	380	1/10/120
4085 85	4	1	380	1/10/120
4085 87	6	1	254	1/10/120
4085 90	10	1	254	1/10/120
4085 92	16	1	254	1/10/120
4085 93	20	1	254	1/10/120
4085 94	25	1	254	1/10/120
4085 95	32	1	254	1/10/120
4085 96	40	1	542	1/10/120
4085 97	50	1	542	1/10/120
4085 98	63	1	542	1/10/120



4085 90

Single pole + Neutral 240 V

4086 02	0.5	2	1034	1/5/60
4086 03	1	2	1034	1/5/60
4086 05	2	2	1034	1/5/60
4086 06	3	2	1034	1/5/60
4086 07	4	2	1034	1/5/60
4086 09	6	2	742	1/5/60
4086 12	10	2	742	1/5/60
4086 14	16	2	742	1/5/60
4086 15	20	2	742	1/5/60
4086 16	25	2	742	1/5/60
4086 17	32	2	742	1/5/60
4086 18	40	2	1200	1/5/60
4086 19	50	2	1200	1/5/60
4086 20	63	2	1200	1/5/60



4086 14

Double pole 415 V

4086 21	0.5	2	1034	1/40
4086 22	1	2	1034	1/40
4086 24	2	2	1034	1/40
4086 25	3	2	1034	1/40
4086 26	4	2	1034	1/40
4086 28	6	2	742	1/40
4086 31	10	2	742	1/40
4086 33	16	2	742	1/40
4086 34	20	2	742	1/40
4086 35	25	2	742	1/40
4086 36	32	2	742	1/40
4086 37	40	2	1200	1/40
4086 38	50	2	1200	1/40
4086 39	63	2	1200	1/40



4086 37

Triple pole 415 V

4086 43	0.5	3	1602	1/32
4086 44	1	3	1602	1/32
4086 46	2	3	1602	1/32
4086 47	3	3	1602	1/32
4086 48	4	3	1602	1/32
4086 50	6	3	1216	1/32
4086 53	10	3	1216	1/32
4086 55	16	3	1216	1/32
4086 56	20	3	1216	1/32
4086 57	25	3	1216	1/32
4086 58	32	3	1216	1/32
4086 59	40	3	1858	1/32
4086 60	50	3	1858	1/32
4086 61	63	3	1858	1/32



4086 55

* MRP - Maximum Retail Price Inclusive of all taxes.

Red Cat.Nos - new products

† For further details on product contact nearest Legrand Sales Office.

NEW!

DX³ MCBs

Cat.Nos	Nominal Rating	Number of 17.5 mm modules	MRP* ₹ / Unit	Pack
---------	----------------	---------------------------	---------------	------

Triple pole + Neutral 415 V

4086 65	0.5	4	2008	1/32
4086 66	1	4	2008	1/32
4086 68	2	4	2008	1/32
4086 69	3	4	2008	1/32
4086 70	4	4	2008	1/32
4086 72	6	4	1636	1/32
4086 75	10	4	1636	1/32
4086 77	16	4	1636	1/32
4086 78	20	4	1636	1/32
4086 79	25	4	1636	1/32
4086 80	32	4	1636	1/32
4086 81	40	4	2360	1/32
4086 82	50	4	2360	1/32
4086 83	63	4	2360	1/32



4086 77

Four pole 415 V

4086 84	0.5	4	2008	1/32
4086 85	1	4	2008	1/32
4086 87	2	4	2008	1/32
4086 88	3	4	2008	1/32
4086 89	4	4	2008	1/32
4086 91	6	4	1636	1/32
4086 94	10	4	1636	1/32
4086 96	16	4	1636	1/32
4086 97	20	4	1636	1/32
4086 98	25	4	1636	1/32
4086 99	32	4	1636	1/32
4087 00	40	4	2360	1/32
4087 01	50	4	2360	1/32
4087 02	63	4	2360	1/32



4086 94

D Curve

Single pole 240/415 V

4087 06	0.5	1	380	1/10/120
4087 07	1	1	380	1/10/120
4087 09	2	1	380	1/10/120
4087 10	3	1	380	1/10/120
4087 11	4	1	380	1/10/120
4087 12	6	1	320	1/10/120
4087 14	10	1	320	1/10/120
4087 16	16	1	320	1/10/120
4087 17	20	1	320	1/10/120
4087 18	25	1	320	1/10/120
4087 19	32	1	320	1/10/120
4087 20*	40	1	574	1/10/120
4087 21*	50	1	574	1/10/120
4087 22*	63	1	574	1/10/120



4087 19

Single pole + Neutral 240 V

4087 26	0.5	2	1034	1/5/60
4087 27	1	2	1034	1/5/60
4087 29	2	2	1034	1/5/60
4087 30	3	2	1034	1/5/60
4087 31	4	2	1034	1/5/60

Double pole 415 V

4087 32	0.5	2	1034	1/40
4087 33	1	2	1034	1/40
4087 35	2	2	1034	1/40
4087 36	3	2	1034	1/40
4087 37	4	2	1034	1/40
4087 38	6	2	766	1/40
4087 40	10	2	766	1/40
4087 42	16	2	766	1/40
4087 43	20	2	766	1/40
4087 44	25	2	766	1/40
4087 45	32	2	766	1/40
4087 46*	40	2	1238	1/40
4087 47*	50	2	1238	1/40
4087 48*	63	2	1238	1/40



4087 46

Bold Cat.Nos are products normally available with Legrand (India) Stockists. Cat.Nos that are not bold - delivery within 4 - 8 weeks from the date of order. Bold packing quantity is our mandatory packing. Orders to be placed by Legrand (India) Stockist in multiples of the same.

NEW!

DX³ MCBs

Cat.Nos	Nominal Rating	Number of 17.5 mm modules	MRP* ₹ / Unit	Pack
---------	----------------	---------------------------	---------------	------

Triple pole 415 V

4087 52	0.5	3	1602	1/32
4087 53	1	3	1602	1/32
4087 55	2	3	1602	1/32
4087 56	3	3	1602	1/32
4087 57	4	3	1602	1/32
4087 58	6	3	1264	1/32
4087 60	10	3	1264	1/32
4087 62	16	3	1264	1/32
4087 63	20	3	1264	1/32
4087 64	25	3	1264	1/32
4087 65	32	3	1264	1/32
4087 66*	40	3	1948	1/32
4087 67*	50	3	1948	1/32
4087 68*	63	3	1948	1/32



4087 52

Triple pole + Neutral 415 V

4087 72	0.5	4	2008	1/32
4087 73	1	4	2008	1/32
4087 75	2	4	2008	1/32
4087 76	3	4	2008	1/32
4087 77	4	4	2008	1/32

Four pole 415 V

4087 78	0.5	4	2008	1/32
4087 79	1	4	2008	1/32
4087 81	2	4	2008	1/32
4087 82	3	4	2008	1/32
4087 83	4	4	2008	1/32
4087 84	6	4	1682	1/32
4087 86	10	4	1682	1/32
4087 88	16	4	1682	1/32
4087 89	20	4	1682	1/32
4087 90	25	4	1682	1/32
4087 91	32	4	1682	1/32
4087 92*	40	4	2426	1/32
4087 93*	50	4	2426	1/32
4087 94*	63	4	2426	1/32



4087 90

Circuit breakers AC applications 80 - 125 A

10 kA as per IEC 60947-2
Integrated label holder
Sliding insulating shield
Color coded contact indication window
IP 20 protected terminals
50 sq mm terminals



4086 00

Single pole 230 V / 400 V

4085 99	80	1.5	1976	1/5/160
4086 00	100	1.5	2214	1/5/161
4086 01	125	1.5	2390	1/5/162



4086 40

Double pole 230 V / 400 V

4086 40	80	3	4380	1/5/60
4086 41	100	3	4674	1/5/60
4086 42	125	3	5138	1/5/60



4086 63

Triple pole 400 V

4086 62	80	4.5	6906	1/9
4086 63	100	4.5	7360	1/9
4086 64	125	4.5	8166	1/9



4087 05

Four pole 400 V

4087 03	80	6	9000	1/9
4087 04	100	6	9380	1/9
4087 05	125	6	10612	1/9

* MRP - Maximum Retail Price Inclusive of all taxes.

Red Cat.Nos - new products

* For further details on product contact nearest Legrand Sales Office.

NEW!

DX³ MCBs

Cat.Nos	Nominal Rating	Number of 17.5 mm modules	MRP* ₹ / Unit	Pack
---------	----------------	---------------------------	---------------	------

Circuit breakers DC applications upto 63 A

6 kA as per IEC 60947-2
Integrated label holder
Sliding bottom clamp
Improved air channels
Color coded On/Off indication on dolly
Biconnect lower terminals
IP 20 protected terminals
Sliding shutters

Single pole 250 V

4087 98*	0.5	1	604	1/10/120
4087 99*	1	1	604	1/10/120
4088 01*	2	1	604	1/10/120
4088 02*	3	1	604	1/10/120
4088 03*	4	1	604	1/10/120
4088 04*	6	1	512	1/10/120
4088 06*	10	1	512	1/10/120
4088 08*	16	1	512	1/10/120
4088 09*	20	1	512	1/10/120
4088 10*	25	1	512	1/10/120
4088 11*	32	1	512	1/10/120
4088 12*	40	1	674	1/10/120
4088 13*	50	1	674	1/10/120
4088 14*	63	1	674	1/10/120



4088 12

Double pole 250 V

4088 15*	0.5	1	1236	1/5/60
4088 16*	1	1	1236	1/5/60
4088 18*	2	1	1236	1/5/60
4088 19*	3	1	1236	1/5/60
4088 20*	4	1	1236	1/5/60
4088 21*	6	1	1082	1/5/60
4088 23*	10	1	1082	1/5/60
4088 25*	16	1	1082	1/5/60
4088 26*	20	1	1082	1/5/60
4088 27*	25	1	1082	1/5/60
4088 28*	32	1	1082	1/5/60
4088 29*	40	1	1362	1/5/60
4088 30*	50	1	1362	1/5/60
4088 31*	63	1	1362	1/5/60

DX³ isolators

Isolators for AC applications upto 125 A

ISI marked as per IEC 60947-3
Integrated label holder
Ergonomic red color dolly
Sliding bottom clamp
Double break mechanism
Improved air channels
Color coded On/Off indication on dolly
Biconnect lower terminals
IP 20 protected terminals
Sliding shutters



4065 00

Double pole 240 V

4065 00	32	2	414	1/5/60
4065 01	40	2	454	1/5/60
4065 02	63	2	596	1/5/60
4065 04	100	2	810	1/5/60
4065 05	125	2	922	1/5/60

Triple pole 415 V

4065 09	32	3	732	1/40
4065 10	40	3	782	1/40
4065 11	63	3	926	1/40
4065 13	100	3	1034	1/40
4065 14	125	3	1196	1/40



4065 10

Four pole 415 V

4065 18	32	4	814	1/32
4065 19	40	4	1010	1/32
4065 20	63	4	1104	1/32
4065 22	100	4	1348	1/32
4065 23	125	4	1484	1/32



4065 20

Bold Cat.Nos are products normally available with Legrand (India) Stockists. Cat.Nos that are not bold - delivery within 4 - 8 weeks from the date of order. Bold packing quantity is our mandatory packing. Orders to be placed by Legrand (India) Stockist in multiples of the same.

NEW!

DX³ RCCBs

Cat.Nos	Nominal Rating	Number of 17.5 mm modules	MRP* ₹ / Unit	Pack
---------	----------------	---------------------------	---------------	------

RCCBs for AC applications upto 63 A

ISI marked as per IS 12640-1
 Integrated label holder
 Ergonomic Grey color dolly
 Sliding bottom clamp
 Color coded On/Off indication on dolly
 Biconnect lower terminals
 IP 20 protected terminals
 35 sq mm terminals
 Sliding shutters

Double pole 240 V

30 mA

4118 51	25	2	2664	1/5/60
4118 52	40	2	3122	1/5/60
4118 53	63	2	3702	1/5/60

100 mA

4118 56	25	2	2850	1/5/60
4118 57	40	2	3308	1/5/60
4118 58	63	2	3928	1/5/60

300 mA

4118 61	25	2	2904	1/5/60
4118 62	40	2	3380	1/5/60
4118 63	63	2	3954	1/5/60

Four pole 415 V

30 mA

4118 76	25	4	3644	1/32
4118 77	40	4	3630	1/32
4118 78	63	4	4210	1/32

100 mA

4118 81	25	4	3780	1/32
4118 82	40	4	3804	1/32
4118 83	63	4	4490	1/32

300 mA

4118 86	25	4	3872	1/32
4118 87	40	4	3928	1/32
4118 88	63	4	4490	1/32

Four pole 415 V, A-S

300 mA

4118 91	25	2	5612	1/5/60
4118 92	40	2	5812	1/5/60
4118 93	63	2	5966	1/5/60
4118 94	80	2	7012	1/5/60

Double pole 240 V, HPI

30 mA

4118 71	25	2	5564	1/5/60
4118 72	40	2	5842	1/5/60
4118 73	63	2	6010	1/5/60
4118 74	80	2	7234	1/5/60

Four pole 415 V, HPI

30 mA

4118 96	25	4	6234	1/32
4118 97	40	4	6460	1/32
4118 98	63	4	6630	1/32
4118 99	80	4	7864	1/32

* MRP - Maximum Retail Price Inclusive of all taxes.
 Red Cat.Nos - new products



4118 51



4118 57



4118 77



4118 83



4118 93



4118 97

NEW!

DX³ circuit breakers

Cat.Nos	Nominal Rating	Number of 17.5 mm modules	MRP* ₹ / Unit	Pack
---------	----------------	---------------------------	---------------	------

AC applications upto 100 A

Integrated label holder
 Ergonomic Grey color dolly
 Color coded On/Off indication on dolly
 Biconnect lower terminals
 IP 20 protected terminals
 35 sq mm terminals
 Sliding shutters

Double pole 240 V

30 mA

4115 07	80	2	6186	1/5/60
4115 08	100	2	6724	1/5/60

100 mA

4115 17	80	2	6186	1/5/60
4115 18	100	2	6724	1/5/60

300 mA

4115 27	80	2	6186	1/5/60
4115 28	100	2	6724	1/5/60

Four pole 415 V

30 mA

4117 05	80	4	7262	1/32
4117 63	100	4	7800	1/32

100 mA

4117 15	80	4	7262	1/32
4117 73	100	4	7800	1/32

300 mA

4117 25	80	4	7262	1/32
4117 83	100	4	7800	1/32

DX³ RCBOs

RCBOs assembled for AC applications upto 63 A

ISI marked as per IS 12640-2
 Integrated label holder
 Ergonomic design
 Color coded On/Off indication on dolly
 Front face indication for earth leakage fault
 IP 20 protected terminals
 35 sq mm terminals
 Sliding shutters

Double pole 240 V, AC Type

30 mA

4113 22	6	4	3262	1/32
4113 23	10	4	3230	1/32
4113 24	16	4	3152	1/32
4113 25	25	4	3152	1/32
4113 26	32	4	3448	1/32
4113 27	40	4	4072	1/32
4113 28	63	4	4870	1/32

100 mA

4113 29	6	4	4024	1/32
4113 30	10	4	4024	1/32
4113 31	16	4	3872	1/32
4113 32	25	4	3872	1/32
4113 33	32	4	3872	1/32
4113 34	40	4	4456	1/32
4113 35	63	4	5156	1/32

300 mA

4113 36	16	4	3964	1/32
4113 37	25	4	3964	1/32
4113 38	32	4	3964	1/32
4113 39	40	4	4538	1/32
4113 40	63	4	5202	1/32

Bold Cat.Nos are products normally available with Legrand (India) Stockists.
 Cat.Nos that are not bold - delivery within 4 - 8 weeks from the date of order.
 Bold packing quantity is our mandatory packing. Orders to be placed by Legrand (India) Stockist in multiples of the same.



4115 08



4115 27



4117 05



4117 15



4117 25



4113 24

NEW!

DX³ RCBOs

Cat.Nos	Nominal Rating	Number of 17.5 mm modules	MRP* ₹ / Unit	Pack
---------	----------------	---------------------------	---------------	------

Four pole 415 V, AC Type

30 mA

4113 88	6	7	4472	1/16
4113 89	10	7	4472	1/16
4113 65	16	7	4406	1/16
4113 66	25	7	4406	1/16
4113 67	32	7	4546	1/16
4113 68	40	7	4616	1/16
4113 69	63	7	5506	1/16

Four pole 415 V, AC Type

100 mA

4113 70	16	7	4924	1/16
4113 71	25	7	4710	1/16
4113 72	32	7	4762	1/16
4113 73	40	7	4900	1/16
4113 74	63	7	5610	1/16

Four pole 415 V, AC Type

300 mA

4113 75	16	7	5024	1/16
4113 76	25	7	4850	1/16
4113 77	32	7	4850	1/16
4113 78	40	7	4948	1/16
4113 79	63	7	5610	1/16



4113 79

RCBOs compact for AC applications upto 32 A, 6 kA

Conforms to IEC 60947
 Integrated label holder
 Ergonomic design
 Color coded On/Off indication on dolly
 Front face indication for earth leakage fault
 IP 20 protected terminals
 35 sq mm terminals
 Sliding shutters

Double pole 240 V, AC Type

30 mA

4113 90	6	2	3796	1/32
4113 91	10	2	3796	1/32
4113 92	16	2	3796	1/32
4113 93	20	2	3796	1/32
4113 94	25	2	3796	1/32
4113 95	32	2	3986	1/32



4113 94

300 mA

4113 97	6	2	3904	1/32
4113 98	10	2	3904	1/32
4113 99	16	2	3904	1/32
4114 00	20	2	3904	1/32
4114 01	25	2	3904	1/32
4114 02	32	2	4102	1/32

Double pole 240 V, HPI Type

30 mA

4114 15	25	2	7280	1/32
4114 16	32	2	7696	1/32

* MRP - Maximum Retail Price Inclusive of all taxes.
 Red Cat.Nos - new products

NEW!

DX³ RCBOs

Cat.Nos	Nominal Rating	Number of 17.5 mm modules	MRP* ₹ / Unit	Pack
---------	----------------	---------------------------	---------------	------

RCBOs compact for AC applications upto 32 A, 6 kA

Conforms to IEC 60947
 Integrated label holder
 Ergonomic design
 Color coded On/Off indication on dolly
 Front face indication for earth leakage fault
 IP 20 protected terminals
 35 sq mm terminals
 Sliding shutters

Four pole 415 V, AC Type

30 mA

4111 85	10	4	5162	1/16
4111 86	16	4	5162	1/16
4111 87	20	4	5162	1/16
4111 88	25	4	5162	1/16
4111 89	32	4	5162	1/16



4111 88



4112 08

Four pole 415 V, AC Type

300 mA

4112 04	10	4	5696	1/16
4112 05	16	4	5696	1/16
4112 06	20	4	5696	1/16
4112 07	25	4	5696	1/16
4112 08	32	4	5696	1/16

Four pole 415 V, A Type

30 mA

4112 33	10	4	5824	1/16
4112 34	16	4	5824	1/16
4112 35	20	4	5824	1/16
4112 36	25	4	5824	1/16
4112 37	32	4	5824	1/16

Four pole 415 V, A Type

300 mA

4112 38	10	4	6240	1/16
4112 39	16	4	6240	1/16
4112 40	20	4	6240	1/16
4112 41	25	4	6240	1/16
4112 42	32	4	6240	1/16



4112 42

DX³ RCD add on module

For 125 A

Conform to IEC 61009-1
 AC type : detect AC components faults
 Hpi type : detect faults with AC and DC components, increased immunity to false tripping
 For mounting on the right-hand side of 1.5 module per pole DX³ MCBs
 Easy & fast association mechanism
 Terminal cover for locking
 70 sq mm terminals

Double pole 240 V, AC Type

30 mA

4105 68	125 A	4	11440	1
---------	-------	---	-------	---

100 mA

4105 69	125 A	4	12896	1
---------	-------	---	-------	---

300 mA

4105 71	125 A	4	12896	1
---------	-------	---	-------	---



4105 68

Bold Cat.Nos are products normally available with Legrand (India) Stockists. Cat.Nos that are not bold - delivery within 4 - 8 weeks from the date of order. Bold packing quantity is our mandatory packing. Orders to be placed by Legrand (India) Stockist in multiples of the same.

NEW!

DX³ RCD add on module

Cat.Nos	Nominal Rating	Number of 17.5 mm modules	MRP* ₹ / Unit	Pack
---------	----------------	---------------------------	---------------	------

Four pole 415 V, AC Type

30 mA

4106 25	125 A	4	18720	1
---------	-------	---	-------	---

100 mA

4106 26	125 A	4	20176	1
---------	-------	---	-------	---

300 mA

4106 29	125 A	4	20176	1
---------	-------	---	-------	---

Double pole 240 V, HPI type

30 mA

4105 78	125 A	6	14560	1
---------	-------	---	-------	---

100 mA

4105 79	125 A	6	16432	1
---------	-------	---	-------	---

300 mA

4105 82	125 A	6	16432	1
---------	-------	---	-------	---

Four pole 415 V, HPI type

30 mA

4106 38	125 A	6	24960	1
---------	-------	---	-------	---

100 mA

4106 39	125 A	6	26416	1
---------	-------	---	-------	---

300 mA

4106 42	125 A	6	26416	1
---------	-------	---	-------	---

DX³ auxiliaries

Auxiliaries common for MCBs, Isolators, RCCBs & RCBOs

Easy & fast fixation on site
On site clip on mounting
Clip on fitting on left side

Cat.Nos	Description	Number of 17.5 mm modules	MRP* ₹ / Unit	Pack
---------	-------------	---------------------------	---------------	------

Signalling auxiliaries

4062 50	Auxiliary changeover switch 6 A	0.5	734	1
4062 52	Fault signalling changeover switch 6 A	0.5	862	1
4062 64	Changeover + fault signalling switch	1	1384	1

Control auxiliaries

4062 76	Shunt release 12 /48 V AC/DC	1	2006	1
4062 78	Shunt release 110/415 V V AC	1	2006	1
4062 80	Undervoltage release 24/48 V AC/DC	1	1752	1
4062 82	Undervoltage release 230 V AC	1	1752	1
4062 86	Pop over voltage release	1	2184	1
4062 90	Motor control 24/48 V AC/DC	1	8320	1
4062 91	Motor control 110/415 V AC	1	8320	1
4062 93	Motor control 24/48 V AC/DC	2	18720	1
4062 95	Motor control 110/415 V AC	2	18720	1
4062 88	Automatic resetter	2	8320	1
4062 89	Automatic resetter with autotest	2	12480	1

* MRP - Maximum Retail Price Inclusive of all taxes.
Red Cat.Nos - new products

NEW!

DX³ auxiliaries

Cat.Nos	Description	Number of 17.5 mm modules	MRP* ₹ / Unit	Pack
---------	-------------	---------------------------	---------------	------

Rotary handle

4063 19	Black rotary handle	-	1664	10
4063 20	Yellow/red rotary handle	-	1872	10

Support for padlock

4063 03	Support for padlock till 63 A	-	396	10
---------	-------------------------------	---	-----	----

Sealable screw cover

4063 04	Devices upto 63 A	-	396	10
4063 06	For 80-125 A devices	-	208	10

1/2 module spacing unit

4063 07	1/2 module spacing unit	0.5	146	10
---------	-------------------------	-----	-----	----

5mm padlock

4063 13	5 mm Padlock	-	312	10
---------	--------------	---	-----	----

Manual changover switch

Compact design
Manual switching operation
Easy to assemble
Ergonomic design

For 1 mod/pole devices

4063 14	Manual change-over switch for DP	1	1872	5
4063 15	Manual change-over switch for TP	1	2288	5
4063 16	Manual change-over switch for FP	1	2496	5

DX³ RCD add on module with measurement & metering

Conform to IEC 61009-1
Hpi type: detect faults with AC and DC components, increased
Immunity to false tripping
Inbuilt measurement/metering option
Measurement - V, A, F, PF, kWh, KVA, KVAh, THD
Metering - V, A, F, kWh
RS 485 port for remote reading
Di-electric test button inbuilt
Ergonomic test button
Scroll button for easy readings
RLCD display on front facia
For mounting on the right-hand side of 1.5 module per pole DX³ MCBs
Easy & fast association mechanism
70 sq mm terminals

Cat.Nos	Nominal Rating	Number of 17.5 mm modules	MRP* ₹ / Unit	Pack
---------	----------------	---------------------------	---------------	------

Adjustable metering, four pole 415 V

4106 57	63 A	7	12480	1
4106 58	125 A	7	22880	1

Adjustable measurement

4106 59	125 A	7	24960	1
---------	-------	---	-------	---

Bold Cat.Nos are products normally available with Legrand (India) Stockists.
Cat.Nos that are not bold - delivery within 4 - 8 weeks from the date of order.
Bold packing quantity is our mandatory packing. Orders to be placed by Legrand (India) Stockist in multiples of the same.



4105 78



4062 50



4062 52



4062 78



4062 82



4106 57

NEW!
DX³ time switches

Cat.Nos	Description	MRP* ₹ / Unit	Pack
---------	-------------	------------------	------

Time switches
AlphaRex³ digital time switches

Daily and weekly time switch
Quick and easy programming due to the option to select day blocks, day blocks can be individually set or selected from the blocks Mon–Sun, Mon–Fri or Sat–Sun

Programming with precision to the second
Switch times visible in weekly overview on display

4126 31	AlphaRex ³ D21, 1 channel	4120	1
4126 41	AlphaRex ³ D22, 2 channels	6180	1
4126 34	AlphaRex ³ D21s, 1 channel	4944	1



4126 41



4126 54



4126 57



4126 29

AlphaRex³ digital time switches - Astro

- For switching on/off lights and other electric devices according to the rising/setting of the sun
- With combination function for creating switching programs in which the devices are switched according to astronomical time and/or fixed preset times
- Daily astronomical calculation of the sunrise/sunset times based on the entered location or location coordinates

4126 54	AlphaRex ³ D21 astro, 1 channel	8240	1
4126 57	AlphaRex ³ D22 astro, 2 channels	9476	1

AlphaRex³ yearly time switch

- Yearly and weekly time switch with additional astronomical function for all channels
- 84 switching programs per channel, comprising:
 - 28 weekly programs
 - 28 yearly programs
 - 28 special programs (priority program)

4126 29	AlphaRex ³ DY21, 1 channel	22660	1
4126 30	AlphaRex ³ DY22, 2 channels	23100	1

Programming accessories

4128 72	Data key	1210	1
4128 73	PC adapter for USB port	4120	1

Twilight switches

- Including light sensor
- Wire for light sensor: 2 x 1.5 mm², maximum wire length: 50 m
- LED switching status indicator

4126 23	Luxo switch	5562	1
---------	-------------	------	---

MicroRex analog time switches

In accordance with IEC 60730-1 and 60730-2-7
Manual switching ON/automatic/OFF
Hourly/daily/weekly switching dial with captive segments
Clock precision: +/- 5 min for the daily time switch
-10°C to +55°C operating temperature

4128 23	MicroRex T31 Su/Wi – Daily time switch	5200	1
4128 28	MicroRex W31 Su/Wi – Weekly time switch	5616	1

* MRP - Maximum Retail Price Inclusive of all taxes.
Red Cat.Nos - new products

NEW!
DX³ time switches

Cat.Nos	Description	MRP* ₹ / Unit	Pack
---------	-------------	------------------	------

MicroRex analog time switches

4128 12	MicroRex T31 – Daily time switch	4160	1
4128 13	MicroRex QT31 – Daily time switch	4664	1
4128 14	MicroRex W31 – Weekly time switch	4992	1
4127 90	MicroRex QT11 – Daily time switch	2912	1
4127 94	MicroRex QW11 – Weekly time switch	3392	1



4128 12



4128 14

Accessory

4128 59	Wall bracket	840	1
---------	--------------	-----	---

DX³ contactors
Power contactors CX³

Conform to IEC/EN 61095

Space for power supply busbar on top (up to 25 A)

4125 44	25 A 2 NO contactor	1690	1
4125 45	40 A 2 NO contactor	2888	1
4125 47	63 A 2 NO contactor	3360	1
4125 48	63 A 2 NC contactor	3360	1
4125 49	40 A 3 NO contactor	4830	1
4125 50	63 A 3 NO contactor	5460	1
4125 51	25 A 4 NO contactor	1996	1
4125 53	40 A 4 NO contactor	5096	1
4125 56	63 A 4 NO contactor	6032	1
4125 57	63 A 4 NC contactor	6090	1



4125 44

Signalling auxiliaries for contactors

Auxiliary changeover switch

4124 29	For 1 module contactors 16 A to 25 A	2526	1
4124 30	For 2 module contactors 25 A	2538	1
4124 31	For 40 and 63 A contactors	3328	1

DX³
Guarantee

- The Company, at its discretion, will replace products if they have any manufacturing defect within 1 years.
- The above guarantee is applicable when the products are selected taken into consideration all the technical characteristics of the product published in our catalogue.
- The guarantee is only applicable when the products are installed as per the Company's instructions and not tampered in any manner.
- The guarantee states the Company's entire liability. It does not extend to cover consequential loss or damage or installation costs arising from defective products.

Bold Cat.Nos are products normally available with Legrand (India) Stockists. Cat.Nos that are not bold - delivery within 4 - 8 weeks from the date of order. Bold packing quantity is our mandatory packing. Orders to be placed by Legrand (India) Stockist in multiples of the same.

NEW!

DX³ for photovoltaic applications

Cat.Nos	Description	MRP* ₹ / Unit	Pack
---------	-------------	------------------	------

DC MCBs

Breaking capacity 4.5 kA according to EN 60947-2

800 V_{DC} circuit breakers

4144 24	6 A	■	1
4144 25	8 A	■	1
4144 26	10 A	■	1
4144 27	13 A	■	1
4144 28	16 A	■	1
4144 29	20 A	■	1

1000 V_{DC} circuit breakers

4144 46	10 A	■	1
4144 47	13 A	■	1
4144 48	16 A	■	1
4144 49	20 A	■	1
4144 50	25 A	■	1
4144 51	32 A	■	1

Type 2 voltage surge protectors

DC side protection of photovoltaic installations connected to the low voltage network (without energy storage system)
Conforming to UTE guide C 61-740-51
Protection in common mode and residual current mode (Y mode) 1
Consisting of plug-in modules with LED indicator
Red: modules need to be replaced

Voltage surge protectors

4141 60	600 V= 25KA I _{max}	■	1
4141 51	1000 V 40KA I _{max}	■	1

Plug-in replacement module

4141 90	+/- cassette for voltage surge protector 4141 60	■	1
4141 91	T cassette for voltage surge protector 4141 60	■	1
4141 81	+/- and T cassette for voltage surge protector 4141 51	■	1

DC rotary handle isolating switches

Category of use DC 21B according to EN 60947-3
Double break contacts

600 V_{DC} isolating switches

4142 61	16 A	■	1
4142 62	25 A	■	1
4142 63	32 A	■	1

1000 V_{DC} isolating switches

4142 81	16 A	■	1
4142 82	25 A	■	1
4142 83	32 A	■	1

Accessories

4063 05	Pole separation divider	■	1
4063 07	Spacing unit 0.5 unit	■	10

■ Price available on request.

* MRP - Maximum Retail Price Inclusive of all taxes.

Red Cat.Nos - new products

Safety, simplicity and flexibility

The simplicity and flexibility of the Lexic system allows you to organise your electrical distribution system exactly as you want.

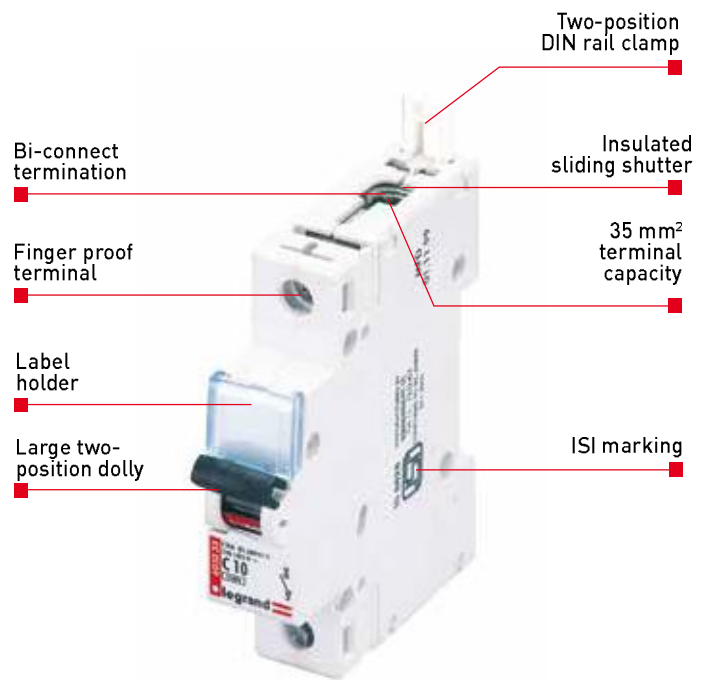

Exclusive features



Integrated label holder for circuit identification



Bi-connect terminals for cable and busbar



Safety shutter for safety



Large cable terminals of 35 mm² capacity for better termination

Bold Cat.Nos are products normally available with Legrand (India) Stockists. Cat.Nos that are not bold - delivery within 4 - 8 weeks from the date of order. Bold packing quantity is our mandatory packing. Orders to be placed by Legrand (India) Stockist in multiples of the same.

Lexic MCBs - C curve - 10 kA

Cat.Nos	Amps.	MRP* ₹ / Unit	Pack
Single pole			
6032 31	6 A	282	1/10/120
6032 33	10 A	282	1/10/120
6032 34	16 A	282	1/10/120
6032 35	20 A	282	1/10/120
6032 36	25 A	282	1/10/120
6032 37	32 A	282	1/10/120
6032 38	40 A	600	1/10/120
6032 39	50 A	600	1/10/120
6032 40	63 A	600	1/10/120
0063 83	80 A	2278	1/5/60
0063 84	100 A	2550	1/5/60
0063 85	125 A	2754	1/5/60



6032 31

Single pole & neutral

6032 48	6 A	818	1/5/60
6032 50	10 A	818	1/5/60
6032 51	16 A	818	1/5/60
6032 52	20 A	818	1/5/60
6032 53	25 A	818	1/5/60
6032 54	32 A	818	1/5/60
6032 55	40 A	1342	1/5/60
6032 56	50 A	1342	1/5/60
6032 57	63 A	1342	1/5/60



6032 48

Double pole

6032 65	6 A	818	1/5/60
6032 67	10 A	818	1/5/60
6032 68	16 A	818	1/5/60
6032 69	20 A	818	1/5/60
6032 70	25 A	818	1/5/60
6032 71	32 A	818	1/5/60
6032 72	40 A	1342	1/5/60
6032 73	50 A	1342	1/5/60
6032 74	63 A	1342	1/5/60
0064 75	80 A	5050	1/40
0064 76	100 A	5388	1/40
0064 77	125 A	5922	1/40



6032 67

Triple pole

6032 82	6 A	1342	1/40
6032 84	10 A	1342	1/40
6032 85	16 A	1342	1/40
6032 86	20 A	1342	1/40
6032 87	25 A	1342	1/40
6032 88	32 A	1342	1/40
6032 89	40 A	2050	1/40
6032 90	50 A	2050	1/40
6032 91	63 A	2050	1/40
0064 95	80 A	7960	1/9
0064 96	100 A	8484	1/9
0064 97	125 A	9412	1/9



6032 88

Triple pole & neutral

6032 99	6 A	1800	1/32
6033 01	10 A	1800	1/32
6033 02	16 A	1800	1/32
6033 03	20 A	1800	1/32
6033 04	25 A	1800	1/32
6033 05	32 A	1800	1/32
6033 06	40 A	2622	1/32
6033 07	50 A	2622	1/32
6033 08	63 A	2622	1/32



6033 08

Four pole

6033 16	6 A	1800	1/32
6033 18	10 A	1800	1/32
6033 19	16 A	1800	1/32

Lexic MCBs - C curve - 10 kA

Cat.Nos	Amps.	MRP* ₹ / Unit	Pack
Four pole			
6033 20	20 A	1800	1/32
6033 21	25 A	1800	1/32
6033 22	32 A	1800	1/32
6033 23	40 A	2622	1/32
6033 24	50 A	2622	1/32
6033 25	63 A	2622	1/32
0065 70	80 A	10374	1/9
0065 71	100 A	10810	1/9
0065 72	125 A	12228	1/9



6033 22

Lexic MCBs - D curve - 10 kA

Single pole

6032 24	0.5 A	424	1/10/120
6032 25	1 A	424	1/10/120
6032 26	1.6 A	424	1/10/120
6032 27	2 A	424	1/10/120
6032 28	3 A	424	1/10/120
6032 29	4 A	424	1/10/120
6049 51	6 A	370	1/10/120
6049 52	10 A	370	1/10/120
6049 53	16 A	370	1/10/120
6049 54	20 A	370	1/10/120
6049 55	25 A	370	1/10/120
6049 56	32 A	370	1/10/120
6049 57	40 A	624	1/10/120
6049 58	50 A	624	1/10/120
6049 59	63 A	624	1/10/120



6049 51

Movement Detectors

For lighting control

360° detection range



Refer p. 130

* MRP - Maximum Retail Price Inclusive of all taxes.

Bold Cat.Nos are products normally available with Legrand (India) Stockists. Cat.Nos that are not bold - delivery within 4 - 8 weeks from the date of order. Bold packing quantity is our mandatory packing. Orders to be placed by Legrand (India) Stockist in multiples of the same.

Lexic MCBs - D curve - 10 kA

Cat.Nos	Amps.	MRP* ₹ / Unit	Pack
---------	-------	------------------	------

Single pole & neutral

6032 41	0.5 A	1104	1/5/60
6032 42	1 A	1160	1/5/60
6032 43	1.6 A	1160	1/5/60
6032 44	2 A	1160	1/5/60
6032 45	3 A	1160	1/5/60
6032 46	4 A	1160	1/5/60



6032 46

Double pole

6032 58	0.5 A	1160	1/5/60
6032 59	1 A	1160	1/5/60
6032 60	1.6 A	1160	1/5/60
6032 61	2 A	1160	1/5/60
6032 62	3 A	1160	1/5/60
6032 63	4 A	1160	1/5/60
6049 61	6 A	882	1/5/60
6049 62	10 A	882	1/5/60
6049 63	16 A	882	1/5/60
6049 64	20 A	882	1/5/60
6049 65	25 A	882	1/5/60
6049 66	32 A	834	1/5/60
6049 67	40 A	1344	1/5/60
6049 68	50 A	1344	1/5/60
6049 69	63 A	1422	1/5/60



6049 61

Triple pole

6032 75	0.5 A	1800	1/40
6032 76	1 A	1800	1/40
6032 77	1.6 A	1800	1/40
6032 78	2 A	1800	1/40
6032 79	3 A	1800	1/40
6032 80	4 A	1800	1/40
6049 71	6 A	1404	1/40
6049 72	10 A	1404	1/40
6049 73	16 A	1404	1/40
6049 74	20 A	1404	1/40
6049 75	25 A	1404	1/40
6049 76	32 A	1404	1/40
6049 77	40 A	2078	1/40
6049 78	50 A	2078	1/40
6049 79	63 A	2078	1/40



6049 76

Triple pole & neutral

6032 92	0.5 A	2274	1/32
6032 93	1 A	2274	1/32
6032 94	1.6 A	2274	1/32
6032 95	2 A	2274	1/32
6032 96	3 A	2274	1/32
6032 97	4 A	2274	1/32



6032 97

Four pole

6033 09	0.5 A	2274	1/32
6033 10	1 A	2274	1/32
6033 11	1.6 A	2274	1/32
6033 12	2 A	2274	1/32
6033 13	3 A	2274	1/32
6033 14	4 A	2274	1/32
6049 81	6 A	1868	1/32
6049 82	10 A	1868	1/32
6049 83	16 A	1868	1/32
6049 84	20 A	1868	1/32
6049 85	25 A	1868	1/32
6049 86	32 A	1868	1/32
6049 87	40 A	2612	1/32
6049 88	50 A	2612	1/32
6049 89	63 A	2612	1/32



6049 86

* MRP - Maximum Retail Price Inclusive of all taxes.

Lexic MCBs - 250 V DC

Cat.Nos	Amps.	MRP* ₹ / Unit	Pack
---------	-------	------------------	------

Single pole

6034 30	0.5 A	676	1/10/120
6034 31	1 A	676	1/10/120
6034 32	1.6 A	676	1/10/120
6034 33	2 A	676	1/10/120
6034 34	3 A	676	1/10/120
6034 35	4 A	676	1/10/120
6033 33	6 A	568	1/10/120
6033 35	10 A	568	1/10/120
6033 36	16 A	568	1/10/120
6033 37	20 A	568	1/10/120
6033 38	25 A	568	1/10/120
6033 39	32 A	568	1/10/120
6033 40	40 A	748	1/10/120
6033 41	50 A	748	1/10/120
6033 42	63 A	748	1/10/120



6033 33

Double pole

6033 43	0.5 A	1372	1/5/60
6033 44	1 A	1372	1/5/60
6033 45	1.6 A	1372	1/5/60
6033 46	2 A	1372	1/5/60
6033 47	3 A	1372	1/5/60
6033 48	4 A	1372	1/5/60
6033 50	6 A	1202	1/5/60
6033 52	10 A	1202	1/5/60
6033 53	16 A	1202	1/5/60
6033 54	20 A	1202	1/5/60
6033 55	25 A	1202	1/5/60
6033 56	32 A	1202	1/5/60
6033 57	40 A	1514	1/5/60
6033 58	50 A	1514	1/5/60
6033 59	63 A	1514	1/5/60



6033 56

Lexic railway MCBs

For 130 V DC

Single pole

6033 60	0.5 A	588	1/40
6033 61	1.0 A	588	1/40
6033 63	1.6 A	588	1/40
6033 64	2.5 A	588	1/40
6033 65	3.0 A	556	1/40
6033 66	4.0 A	588	1/40
6033 67	5.0 A	532	1/40
6033 68	10 A	532	1/40
6033 69	15 A	532	1/40
6033 70	20 A	532	1/40
6033 71	25 A	532	1/40
6033 72	30 A	532	1/40
6033 73	35 A	532	1/40
6033 74	40 A	694	1/40
6033 75	50 A	694	1/40
6033 76	60 A	694	1/40



6033 67

Lexic isolators

Double pole

6040 01	32 A	456	1/5/60
6040 02	40 A	496	1/5/60
6040 03	63 A	654	1/5/60
6040 05	100 A	828	1/5/60



6040 02

Triple pole

6040 07	32 A	792	1/40
6040 08	40 A	858	1/40
6040 09	63 A	996	1/40
6040 11	100 A	1122	1/40
6040 12	125 A	1300	1/40



6040 08

Bold Cat.Nos are products normally available with Legrand (India) Stockists. Cat.Nos that are not bold - delivery within 4 - 8 weeks from the date of order. Bold packing quantity is our mandatory packing. Orders to be placed by Legrand (India) Stockist in multiples of the same.

Lexic isolators

Cat.Nos	Amps.	MRP* ₹ / Unit	Pack
---------	-------	------------------	------

Four pole

6040 13	32 A	884	1/32
6040 14	40 A	1100	1/32
6040 15	63 A	1204	1/32
6040 17	100 A	1322	1/32
6040 18	125 A	1574	1/32



6040 13

Lexic RCBOs

Earth leakage, overload & short circuit protection

Double pole - sensitivity 30 mA

6034 14	6 A	3656	1/32
6034 16	10 A	3632	1/32
6033 77	16 A	3510	1/32
6033 79	25 A	3510	1/32
6033 80	32 A	3866	1/32
6033 81	40 A	4490	1/32
6033 82	63 A	5324	1/32



6033 80

Double pole - sensitivity 100 mA

6034 24	6 A	4512	1/32
6034 26	10 A	4472	1/32
6033 83	16 A	4326	1/32
6033 85	25 A	4342	1/32
6033 86	32 A	4342	1/32
6033 87	40 A	4846	1/32
6033 88	63 A	5648	1/32



6033 86

Double pole - sensitivity 300 mA

6033 89	16 A	4424	1/32
6033 91	25 A	4444	1/32
6033 92	32 A	4444	1/32
6033 93	40 A	4990	1/32
6033 94	63 A	5754	1/32

Four pole - sensitivity 30 mA

6033 95	16 A	4940	1/16
6033 97	25 A	5078	1/16
6033 98	32 A	5098	1/16
6033 99	40 A	5098	1/16
6034 00	63 A	6052	1/16



6033 99

Four pole - sensitivity 100 mA

6034 01	16 A	5520	1/16
6034 03	25 A	5412	1/16
6034 04	32 A	5338	1/16
6034 05	40 A	5392	1/16
6034 06	63 A	6216	1/16

Four pole - sensitivity 300 mA

6034 07	16 A	5632	1/16
6034 09	25 A	5438	1/16
6034 10	32 A	5414	1/16
6034 11	40 A	5414	1/16
6034 12	63 A	6278	1/16



6034 11

Lexic RCBOs - 2 pole - 2 module

earth leakage, overload & short circuit protection

Double pole - sensitivity 30 mA

0078 60	6 A	4444	1/5/60
0078 61	10 A	4444	1/5/60
0078 63	16 A	4444	1/5/60
0078 64	20 A	4444	1/5/60
0078 65	25 A	4444	1/5/60
0078 66	32 A	4666	1/5/60
0078 67	40 A	5518	1/5/60



0078 63

* MRP - Maximum Retail Price Inclusive of all taxes.

Lexic RCBOs - 2 pole - 2 module

earth leakage, overload & short circuit protection

Cat.Nos	Amps.	MRP* ₹ / Unit	Pack
---------	-------	------------------	------

Double pole - sensitivity 300 mA

0078 71	6 A	4572	1/5/60
0078 72	10 A	4572	1/5/60
0078 74	16 A	4572	1/5/60
0078 75	20 A	4572	1/5/60
0078 76	25 A	4572	1/5/60
0078 77	32 A	4804	1/5/60
0078 78	40 A	5680	1/5/60

Hpi RCBOs

- Enhanced immunity to unwanted tripping in environments with disturbances e.g., DG sets, computers, printer, thyristors etc.

Double pole - sensitivity 30 mA, Hpi - A

0085 67	25 A	8824	1/5/60
0085 68	32 A	9216	1/5/60
0085 69	40 A	10924	1/5/60



0085 67

Lexic RCCBs

earth leakage protection

Double pole - sensitivity 30 mA

0086 06	25 A	3016	1/5/60
0086 07	40 A	3536	1/5/60
0086 08	63 A	4164	1/5/60



0086 08

Double pole - sensitivity 100 mA

0086 09	25 A	3194	1/5/60
0086 10	40 A	3754	1/5/60
0086 11	63 A	4380	1/5/60



0086 11

Double pole - sensitivity 300 mA

0086 12	25 A	3226	1/5/60
0086 13	40 A	3790	1/5/60
0086 14	63 A	4400	1/5/60



0086 14

Double pole - sensitivity 300 mA, A - S (selective)

6021 72	63 A	6594	1/5/60
---------	------	------	--------

Four pole - sensitivity 30 mA

6021 26	25 A	4052	1/32
6021 27	40 A	4070	1/32
6021 28	63 A	4720	1/32



6021 26

Four pole - sensitivity 100 mA

6021 29	25 A	4238	1/32
6021 30	40 A	4308	1/32
6021 31	63 A	4988	1/32

Four pole - sensitivity 300 mA

6021 32	25 A	4302	1/32
6021 33	40 A	4350	1/32
6021 34	63 A	4986	1/32

Four pole - sensitivity 300 mA, A - S (selective)

6021 67	63 A	7372	1/32
---------	------	------	------

Bold Cat.Nos are products normally available with Legrand (India) Stockists. Cat.Nos that are not bold - delivery within 4 - 8 weeks from the date of order. Bold packing quantity is our mandatory packing. Orders to be placed by Legrand (India) Stockist in multiples of the same.

Lexic RCCBs - Hpi

earth leakage protection

Cat.Nos	Amps.	MRP* ₹ / Unit	Pack
---------	-------	------------------	------

Hpi RCCBs

- Enhanced immunity to unwanted tripping in environments with disturbances e.g., DG sets, computers, printers, thyristors etc.

Double pole - sensitivity 30 mA, Hpi - A

6021 68	25 A	6494	1/5/60
6021 69	40 A	6836	1/5/60
6021 70	63 A	7004	1/5/60



6021 68

Four pole - sensitivity 30 mA, Hpi - A

6021 64	25 A	7216	1/32
6021 65	40 A	7456	1/32
6021 66	63 A	7652	1/32



6021 66

Lexic accessories

Cat.Nos	Description	LP* ₹ / Unit	Pack
---------	-------------	-----------------	------

Accessories

0044 42	Support for 4 mm and 6 mm padlock	450	2/100
0044 44	Sealable terminal shield (4 separable poles)	406	2/96
0044 06	3 module clip-on adaptor for Lexic	500	10/100
6034 48	50 mm ² Entry Terminal for MCB / RCCB	102	1
6034 49	50 mm ² Entry Terminal for RCBO	102	1
6017 99	Labels for Label Holder (a set of 10 sheets)	442	1



0073 50

Lexic common auxiliaries

Auxiliaries for MCBs / Isolators / RCDs

0073 50	Auxiliary changeover switch 6 A 250 V AC ½M▲	854	1
0073 51	Fault signalling changeover switch 6 A 250 V AC ½M▲	1002	1
0073 53	Auxiliary changeover which can be modified to a fault signalling switch 6 A 250 V AC ½M▲	1610	1
0073 54	Auxiliary changeover switch + fault signalling switch which can be modified to 2 auxiliary changeover switches 1M▲	2788	1



0073 54

*LP - List Price Inclusive of excise duty but exclusive of sales tax or any other taxes.

*MRP - Maximum Retail Price Inclusive of all taxes.

▲M = Module

Lexic common auxiliaries

Cat.Nos	Description	LP* ₹ / Unit	Pack
---------	-------------	-----------------	------

Auxiliaries for MCBs / Isolators / RCDs

0073 60	Shunt trip 12 to 48 V AC/DC 1M▲	2332	1
0073 61	Shunt trip 110 to 415 V AC & 110 to 125 V DC 1M▲	2332	1
0073 65	Minimum voltage trips time delay adjustable from 0 to 300 ms 24 V DC 1M▲	1944	1
0073 66	Minimum voltage trips time delay adjustable from 0 to 300 ms 48 V DC 1M▲	1944	1
0073 68	Minimum voltage trips time delay adjustable from 0 to 300 ms 230 V AC 1M▲	2038	1
0073 73	Remote control for DP/TP/FP MCBs. Auxiliary change over and fault signalling changeover incorporated - 230 V AC 3M▲	26514	1



0073 60



0073 66



0073 73

Lexic - MPCBs

Motor protection circuit breakers - MPCBs

Provides localised control and protection against overload and short circuit to 3 phase motors; 3 pole - 415 V AC; 2.5 modules.

0028 00	Nominal rating - 0.16 A adjustable thermal range 0.1 - 0.16 A	6416	1/20
0028 01	Nominal rating - 0.25 A adjustable thermal range 0.16 - 0.25 A	6416	1/20
0028 02	Nominal rating - 0.4 A adjustable thermal range 0.25 - 0.4 A	6416	1/20
0028 03	Nominal rating - 0.63 A adjustable thermal range 0.4 - 0.63 A	6416	1/20
0028 04	Nominal rating - 1 A adjustable thermal range 0.63 - 1 A	6416	1/20
0028 05	Nominal rating - 1.6 A adjustable thermal range 1 - 1.6 A	6416	1/20
0028 06	Nominal rating - 2.5 A adjustable thermal range 1.6 - 2.5 A	6416	1/20
0028 07	Nominal rating - 4 A adjustable thermal range 2.5 - 4 A	6416	1/20
0028 08	Nominal rating - 6.3 A adjustable thermal range 4 - 6.3 A	6416	1/20
0028 09	Nominal rating - 10 A adjustable thermal range 6 - 10 A	7386	1/20
0028 10	Nominal rating - 14 A adjustable thermal range 9 - 14 A	8154	1/20
0028 11	Nominal rating - 18 A adjustable thermal range 13 - 18 A	8154	1/20



0028 06

Bold Cat.Nos are products normally available with Legrand (India) Stockists. Cat.Nos that are not bold - delivery within 4 - 8 weeks from the date of order. Bold packing quantity is our mandatory packing. Orders to be placed by Legrand (India) Stockist in multiples of the same.

Lexic - MPCBs

Cat.Nos	Description	LP* ₹ / Unit	Pack
---------	-------------	-----------------	------

Motor protection circuit breakers - MPCBs

0028 12	Nominal rating - 23 A Adjustable thermal range 17 - 23 A	8154	1/20
0028 13	Nominal rating - 25 A Adjustable thermal range 20 - 25 A	9044	1/20
0028 14	Nominal rating - 32 A Adjustable thermal range 24 to 32A	12592	1/20



0028 13

Auxillaries for MPCBs

0028 16	Fault signaling 1NO + 1NC (0.5 module)	1630	1/50
0028 17	Auxiliary contact 1NO+1NC (0.5 module)	1194	1/50
0028 18	Auxiliary contact 2NO (0.5 module)	1394	1/50
0028 22	Undervoltage trip release 230V (1 module)	3018	1/25
0028 23	Undervoltage trip release 400V (1 module)	3018	1/25
0028 25	Shunt trip release 230V (1 module)	3350	1/25
0028 26	Shunt trip release 400V (1 module)	3350	1/25



Accessories for MPCBs

0028 29	Box IP 65 (85mm)	1982	1/4
0028 30	Emergency stop button	2608	1/15
0028 31	Pilot light colourless 220V	610	1/50
0028 32	Pilot light colourless 380V	610	1/50
0028 34	Padlockable attachment	972	1/25



Lexic voltage surge protectors high, increased and standard protection

Voltage surge protectors

Protects appliance against transient micro surges
of 8/20 μ sec.

High protection VSP (H) - 230/400 V AC
Imax - 70 kA, UP - 2.0 kV (protection level)
Type I - II

0039 20	1 Pole (1 module)	7274	1/20
0039 21	2 Pole (2 modules)	12840	1/12
0039 22	3 Pole (3 modules)	19734	1/20
0039 23	4 Pole (4 modules)	25220	1/20



0039 21

Increased protection VSP (E) - 230/400 V AC
Imax - 40 kA, UP - 1.4 kV (protection level)
Type II

0039 35	1 Pole (1 module)	6032	1/20
0039 36	2 Pole (2 modules)	10984	1/12
0039 38	4 Pole (4 modules)	20662	1/20



0039 36

Standard protection VSP (S) - 230/400 V AC
Imax - 15 kA, UP - 1.2 kV (protection level)
Type II

0039 40	1 Pole (1 module)	4614	1/20
0039 41	2 Pole (2 modules)	8598	1/12
0039 43	4 Pole (4 modules)	15790	1/20



0039 41

*LP - List Price Inclusive of excise duty but exclusive of sales tax
or any other taxes.

▲ M = Module

Lexic voltage surge protectors high, increased and standard protection

Cat.Nos	Description	LP* ₹ / Unit	Pack
---------	-------------	-----------------	------

Accessories

Plug-in replacement modules

- ◆ With LED indicator
- ◆ Green LED : surge protector operational
- ◆ Yellow LED : module need replacing

0039 28	For surge protector 0039 20/21/22/23	5492	5/20
0039 39	For surge protector 0039 35/36/38	4204	5/20
0039 44	For surge protector 0039 40/41/43	3366	5/20



0039 28

Signalling auxiliaries

With changeover microswitch

- ◆ 5 A - 250 V AC
- ◆ Clip onto the base of the surge protector

0039 56	For 2 Pole module	3062	1/42
0039 57	For 3 Pole module	3898	1/42
0039 58	For 4 Pole module	4810	1/42

Lexic voltage surge protectors For telephone lines

Protects appliance against transient micro surges of
8/20 μ sec.

0038 28	For analogue telephone line	10102	1
0038 29	For digital telephone line	9102	1



0038 28

Lexic changeover switches

Changeover Switches

Single pole - two way - 250 V AC

0043 82	20 A	1384	10/100
---------	------	------	--------



0043 82

Double pole - two way - 400 V AC

0043 83	20 A	2732	5/50
---------	------	------	------

Double pole - two way with centre off - 400 V AC

0043 86	20 A	2894	5/50
---------	------	------	------

Four pole - two way with centre off - 400 V AC

6040 22	40 A	4320	2/20
---------	------	------	------



6040 22

Bold Cat.Nos are products normally available with Legrand (India) Stockists.
Cat.Nos that are not bold - delivery within 4 - 8 weeks from the date of order.
Bold packing quantity is our mandatory packing. Orders to be placed by
Legrand (India) Stockist in multiples of the same.

Lexic push button

Cat.Nos	Description	LP* ₹ / Unit	Pack
---------	-------------	-----------------	------

Push button cum switch

Push button cum switch - 1 module - 20 A-250 V AC

Single function

0044 53	Contact - 1 NO	1624	10/100
0044 54	Contact - 1 NC	1624	10/60
0044 55	Contact - 2 NO	1624	10/60

Dual function

0044 63	Contact - 1 NO + green indicator	2498	10/100
0044 64	Contact - 1 NC + red indicator	2474	10/60

Lexic indicators

Single indicators - 1 module - 250 V AC

Possible to replace E10 lamps and diffusers.
E10 - 1.2 Watt, 230 V AC

0044 83	Colour - green	922	10/100
0044 84	Colour - red	922	10/100
0044 85	Colour - orange	922	10/100
0044 86	Colour - blue	922	10/100

Accessories

0044 36	Replacement lamps 230 V neon	334	10/200
---------	---------------------------------	-----	--------

Lexic dimmer

Dimmer

1000 W remote dimmer

0036 71	1000 W universal remote control dimmer 6 module	36184	1/10
---------	---	-------	------

Lexic time switches

Multifunction time delay relay

- Supply voltage : 12 to 230 V AC 50/60 Hz and DC
- Output : 8 A - 250 V AC, $\cos\phi = 1$
- Contact NO

0047 44	Multifunction time delay relay	11144	1
---------	-----------------------------------	-------	---

Rex modular time switches

Time lag switch

0047 02	Time lag switch long time (1 module)	6126	10/100
---------	---	------	--------

Rex surface mounting time switches

MaxiRex

6499 15	MaxiRex 4QT (daily)	4672	1/30
6499 14A	MaxiRex 4QTB (daily with IP 53 box)	5394	1
6499 39	MaxiRex 5QW (weekly)	5186	1/30
6499 36A	MaxiRex 4QWB (weekly with IP 53 box)	6014	1

EconoRex

0499 86	EconoRex MQT (24 hrs.)	5114	1/30
---------	------------------------	------	------

*LP-List Price Inclusive of excise duty but exclusive of sales tax or any other taxes.

Rex modular time switches

Cat.Nos	Description	LP* ₹ / Unit	Pack
---------	-------------	-----------------	------

Accessories

0498 32	Clip on support frame for facia mounting of MaxiRex QTT and QWT	322	1/5
0044 09	DIN rail adaptor for MaxiRex QTT and QWT	250	1
0044 07	DIN rail adaptor for EconoRex BQTAP	250	1
6499 49	Terminal cover for 4/5 nominal time switch	224	1/30
6499 48	IP53 box for MaxiRex 4 and 5	730	1/10

Lexic ammeters

Analogue ammeter

Measures the intensity of the current circulating in an electrical circuit in Amperes (A)

0046 02	Direct connection to alternating or direct current range : 0 - 30 A (4 modules)	5030	1/12
0046 00	Connected using a 5 A current transformer (CT) the meter is fitted with an appropriate dial for the intensity of the current being measured (4 modules)	5030	1/12

Measuring dials for ammeter Cat.No 0046 00

0046 10	0 - 50 A	296	2/84
0046 13	0 - 100 A	296	2/84
0046 15	0 - 200 A	296	2/84
0046 17	0 - 300 A	296	2/84
0046 18	0 - 400 A	296	2/84
0046 20	0 - 600 A	296	2/84
0046 21	0 - 800 A	296	2/84
0046 22	0 - 1000 A	296	2/84

Current transformers

- Used with ammeters
- Supply a current of 0 to 5 A to the secondary which is proportional to the primary current.
- Fix to plate or rail EN 50022

0046 31	50/5 Precision in % - 3 Power in VA - 2	2294	1/12
0046 34	100/5 Precision in % - 1 Power in VA - 2	3064	1/12
0046 36	200/5 Precision in % - 1 Power in VA - 4	3174	1/12
0047 75	300/5 Precision in % - 1 Power in VA - 8	3174	1/12
0046 38	400/5 Precision in % - 1 Power in VA - 12	3174	1/12
0047 76	600/5 Precision in % - 1 Power in VA - 15	3220	1/12

Bold Cat.Nos are products normally available with Legrand (India) Stockists. Cat.Nos that are not bold - delivery within 4 - 8 weeks from the date of order. Bold packing quantity is our mandatory packing. Orders to be placed by Legrand (India) Stockist in multiples of the same.

Lexic ammeters

Cat.Nos	Description	LP* ₹ / Unit	Pack
---------	-------------	-----------------	------

Current transformers

0047 77	800/5 Precision in % - 1 Power in VA - 12	4716	1/12
0047 78	1000/5 Precision in % - 1 Power in VA - 12	5442	1/12
0047 79	1200/5 Precision in % - 1 Power in VA - 15	6348	1/12

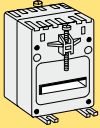
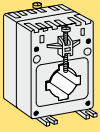

Lexic voltmeters

Analogue voltmeter

Used to measure the AC or DC voltage (V) in an electrical circuit

0046 60	Range 0-500 V - 4M [▲]	5278	1/12
---------	---------------------------------	------	------

Digital ammeter / voltmeter

0046 63	0-1200 A 0-500 V	13398	1
---------	---------------------	-------	---



0046 63

Lexic selector switches

Selector switches

For manual switching of circuits being measured

4-position ammeter selector switch

0046 50	For measuring currents in a 3-phase circuit using only 1 ammeter with a current transformer - 3M [▲]	5520	1/20
---------	---	------	------

4-position voltmeter selector switch

0046 52	For measuring phase-to-phase voltages of a 3-phase circuit without neutral using only 1 voltmeter - 3M [▲]	5066	1/20
---------	---	------	------



0046 52

7-position voltmeter selector switch

0046 53	For measuring phase-to-phase voltages and phase-neutral voltages of a 3-phase circuit with neutral - 3M [▲]	5342	1/20
---------	--	------	------



0046 53



Ekinoxe™

Next generation of Distribution Boards

Refer p. 46-49

*LP- List Price Inclusive of excise duty but exclusive of sales tax or any other taxes.

▲M = Module

Ekinoxe™ MCCB DBs for DPX³ MCCBs



> As per IS 8623

> Available in 4, 6, 8 and 12 ways

> Fully insulated busbars and neutral bars

> Reversible doors for IP43 and IP54 distribution boards

> Provision for DPX³ 160 and DPX³ 250 MCCB as incomer and SP/TP MCBs as outgoing

Bold Cat.Nos are products normally available with Legrand (India) Stockists. Cat.Nos that are not bold - delivery within 4 - 8 weeks from the date of order. Bold packing quantity is our mandatory packing. Orders to be placed by Legrand (India) Stockist in multiples of the same.

Aesthetic Design

Made to be sleek and stylish. For the most elegant eye-catching distribution boards, look no further than Ekinoxe

- E-curves
- One-look
- Smart colour



Total Protection

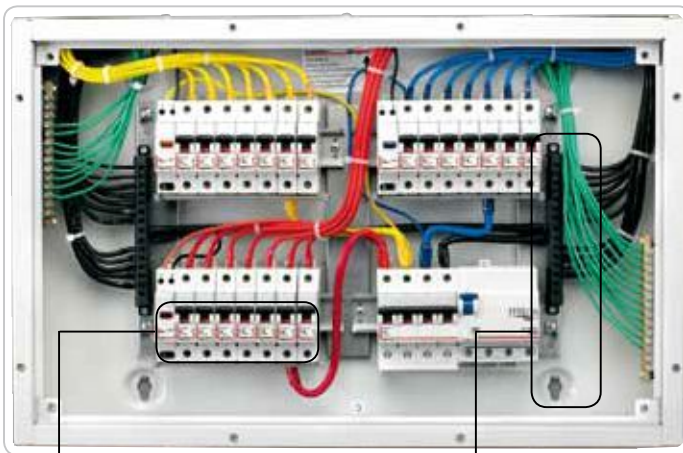

Busbar and neutral links are shrouded. Thus, there's no chance of accidental contact with live parts, and no possibility of shock during use.

- Insulated Busbar
- Shrouded Neutral bar
- Door earthing
- CornerSafe
- IP 20, IP 43 & IP 54
- IK 08, IK 09



Protect Plus for Busbars



Safe Shroud for Neutral Links



Compact Busbar assembly



CornerSafe

User Friendly



Pan Assembly (PPI Kit)



Door and shield independent



DustGuard Masking Sheet

So safe, So good looking

With Ekinox, you have a variety of distribution boards that think 'Safety First'. Combined perfectly with great aesthetics, that suit any decor, Ekinox is ready for use in residences, offices, commercial and industrial complexes.



Ekinox™ distribution boards

Cat.Nos	Number of ways	No. of modules	LP* ₹ / Unit	Pack
---------	----------------	----------------	--------------	------

SPN DBs

For DX³/Lexic MCB, Isolator, RCCB and RCBO
IP 20 - #K 08

6077 00	4 way	4	1078	1
6077 01	8 way	8	1350	1
6077 02	12 way	12	1600	1
6077 03	16 way	16	1972	1

6077 00

IP 43 - #K 09 with metal door

6077 10	4 way	4	1454	1
6077 11	8 way	8	1802	1
6077 12	12 way	12	2168	1
6077 13	16 way	16	2722	1
6077 24	18 way	18	2800	1

6077 10

IP 43 - #K 09 with acrylic door

6077 20	4 way	4	1846	1
6077 21	8 way	8	2156	1
6077 22	12 way	12	2610	1
6077 23	16 way	16	3228	1

6077 20

IP 54 - #K 09

6077 30	4 way	4	4850	1
6077 31	8 way	8	5700	1
6077 32	12 way	12	6580	1
6077 33	16 way	16	7284	1

6077 30

TPN DBs - ETPN DBs

For DX³/Lexic MCB, Isolator, RCCB and RCBO
With provision for FP MCB/Isolator/RCCB/RCBO as in-comer and SP MCBs as outgoing
Can be converted to PPI DB at site by using conversion kit (refer p. 50)

IP 20 - #K 08

6077 05	4 way	8+12	2990	1
6077 06	6 way	8+18	3688	1
6077 07	8 way	8+24	4336	1
6077 08	12 way	8+36	6426	1
6077 09	16 way	8+48	7924	1

6077 07

IP 43 - #K 09 with metal door

6077 15	4 way	8+12	3572	1
6077 16	6 way	8+18	4406	1
6077 17	8 way	8+24	5282	1
6077 18	12 way	8+36	7914	1
6077 19	16 way	8+48	9764	1

6077 17

IP 43 - #K 09 with acrylic door

6077 25	4 way	8+12	4622	1
6077 26	6 way	8+18	5706	1
6077 27	8 way	8+24	6844	1
6077 28	12 way	8+36	10496	1
6077 29	16 way	8+48	12596	1

6077 27

IP 54 - #K 09

6077 35	4 way	8+12	11610	1
6077 36	6 way	8+18	13972	1
6077 37	8 way	8+24	15280	1
6077 38	12 way	8+36	21536	1
6077 39	16 way	8+48	25844	1

6077 37

*LP - List Price Inclusive of excise duty but exclusive of sales tax or any other taxes.

#K - Refer pg - 50 for ready reckoner table.

Red Cat.Nos - new products

Ekinox™ distribution boards

Cat.Nos	Number of ways	No. of modules	LP* ₹ / Unit	Pack
---------	----------------	----------------	--------------	------

TPN DBs - 7 segment DBs

For DX³/Lexic MCB, Isolator, RCCB and RCBO
With provision for FP MCB/Isolator/RCCB/RCBO as in-comer, DP MCB/Isolator/RCCB/RCBO as subin-comer and SP MCBs as outgoing

IP 20 - #K 08

6078 25	4 way	8+12+12	9148	1
6078 26	6 way	8+12+18	9964	1
6078 27	8 way	8+12+24	10666	1
6078 28	12 way	8+12+36	12398	1



6078 25

IP 42 - #K 09 with metal door

6078 35	4 way	8+12+12	9206	1
6078 36	6 way	8+12+18	10378	1
6078 37	8 way	8+12+24	11470	1
6078 38	12 way	8+12+36	14564	1



6078 35

TPN DBs - 7 segment DBs

Common for DX³/Lexic MCB, Isolator and RCD

Cat.Nos	Number of ways	LP* ₹ / Unit	Pack
---------	----------------	--------------	------

With phase segregation and separation between incoming and outgoing.

IP 20 protection

6014 50 G	4	8456	1
6014 51 G	6	9218	1
6014 52 G	8	9878	1
6014 53 G	12	11372	1

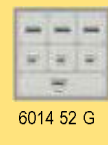

6014 52 G

IP 42 protection - metal door

6014 54 G	4	9242	1
6014 55 G	6	10412	1
6014 56 G	8	11626	1
6014 57 G	12	14838	1

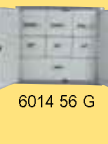

6014 56 G

TPN DBs - phase selector DBs

For DX³/Lexic MCB, Isolator, RCCB and RCBO

Cat.Nos	Number of ways	No. of modules	LP* ₹ / Unit	Pack
---------	----------------	----------------	--------------	------

With provision for FP MCB/Isolator/RCCB/RCBO as in-comer and SP MCBs as outgoing with inbuilt 3 nos. of 63 A phase selector switches and 3 nos. piano switches

IP 20 - #K 08

6078 65	4 way	8+12	11638	1
6078 66	6 way	8+18	12378	1
6078 67	8 way	8+24	13714	1
6078 68	12 way	8+36	15058	1



6078 66

IP 42 - #K 09 with metal door

6078 75	4 way	8+12	12588	1
6078 76	6 way	8+18	12790	1
6078 77	8 way	8+24	13704	1
6078 78	12 way	8+36	15428	1



6078 76

Bold Cat.Nos are products normally available with Legrand (India) Stockists. Cat.Nos that are not bold - delivery within 4 - 8 weeks from the date of order. Bold packing quantity is our mandatory packing. Orders to be placed by Legrand (India) Stockist in multiples of the same.

Ekinox™ distribution boards

Cat.Nos	Number of ways	No. of modules	LP* ₹ / Unit	Pack
---------	----------------	----------------	-----------------	------

TPN DBs - VTPN DBs

For DX³/Lexic MCB, Isolator, RCCB and RCBO

With provision for FP
MCB/Isolator/RCCB/RCBO
as incomer and SP / TP MCBs as outgoing till 63 A

IP 20 - #IK 08

6077 40	4 way	8+12	8336	1
6077 41	8 way	8+24	10178	1
6077 42	12 way	8+36	14700	1

IP 43 - #IK 09 with metal door

6077 50	4 way	8+12	8806	1
6077 51	8 way	8+24	11202	1
6077 52	12 way	8+36	15000	1

IP 43 - #IK 09 with acrylic door

6077 60	4 way	8+12	11872	1
6077 61	8 way	8+24	15090	1
6077 62	12 way	8+36	20134	1

IP 54 - #IK 09

6077 70	4 way	8+12	18806	1
6077 71	8 way	8+24	22622	1
6077 72	12 way	8+36	30142	1

7 Segment DPX³ MCCB DBs

for DX³/Lexic MCB, Isolator, RCCB and RCBO

IP 20 - IK 08

6079 28	4 way	DPX ³ 160+ 12+12	12086	1
6079 30	6 way	DPX ³ 160+ 18+12	13906	1
6079 31	8 way	DPX ³ 160+ 24+12	15980	1
6079 32	12 way	DPX ³ 160+ 36+12	18554	1

TPN DBs - 7 segment DPX³ MCCB DBs

for DX³/Lexic MCB, Isolator, RCCB and RCBO

IP 42 - IK 09 with metal door

6079 33	4 way	DPX ³ 160+ 12+12	13312	1
6079 34	6 way	DPX ³ 160+ 18+12	15234	1
6079 35	8 way	DPX ³ 160+ 24+12	17444	1
6079 36	12 way	DPX ³ 160+ 36+12	19868	1

TPN DBs - DPX³ 160 MCCB DBs for DX³/Lexic MCB

IP 20 - IK 08

6079 10	4 way	DPX ³ 160+12	9616	1
6079 11	8 way	DPX ³ 160+24	11380	1
6079 12	12 way	DPX ³ 160+36	17204	1

*LP - List Price Inclusive of excise duty but exclusive of sales tax or any other taxes.

#IK - Refer pg - 50 for ready reckoner table.

Red Cat.Nos - new products

Ekinox™ distribution boards

Cat.Nos	Number of ways	No. of modules	LP* ₹ / Unit	Pack
---------	----------------	----------------	-----------------	------

TPN DBs - DPX³ 160 MCCB DBs

for DX³/Lexic MCB till 63 A as outgoing

IP 43 - IK 09 with metal door

6079 13	4 way	DPX ³ 160+12	10562	1
6076 95	6 way	DPX ³ 160+18	12000	1
6079 14	8 way	DPX ³ 160+24	13270	1
6079 15	12 way	DPX ³ 160+36	17662	1

IP 54 - IK 09

6079 16	4 way	DPX ³ 160+12	21640	1
6079 17	8 way	DPX ³ 160+24	26014	1
6079 18	12 way	DPX ³ 160+36	34934	1

TPN DBs - DPX³ 250 MCCB DBs

for DX³/Lexic MCB till 63 A as outgoing

IP 20 - IK 08

6079 19	4 way	DPX ³ 250+12	17516	1
6079 20	8 way	DPX ³ 250+24	18802	1
6079 21	12 way	DPX ³ 250+36	20956	1

IP 43 - IK 09 with metal door

6079 22	4 way	DPX ³ 250+12	19554	1
6079 23	8 way	DPX ³ 250+24	22832	1
6079 24	12 way	DPX ³ 250+36	24064	1

IP 54 - IK 09

6079 25	4 way	DPX ³ 250+12	30510	1
6079 26	8 way	DPX ³ 250+24	34456	1
6079 27	12 way	DPX ³ 250+36	40348	1

Flexy DB

For DX³/Lexic modular products

IP 20 - #IK 08

6077 45	2 row of 13 modules	26	3788	1
6077 55	3 row of 13 modules	39	4546	1
6077 65	4 row of 13 modules	52	5210	1

IP 43 - #IK 09 with metal door

6077 46	2 row of 13 modules	26	4466	1
6077 56	3 row of 13 modules	39	5366	1
6077 66	4 row of 13 modules	52	5844	1
6077 68	8 modules 4 row	32	5400	1
6077 69	10 modules 4 row	40	5600	1
6076 96	13 modules 4 row DPX ³ 160 MCCB	52	5900	1

IP 43 - #IK 09 with acrylic door

6077 47	2 row of 13 modules	26	4724	1
6077 57	3 row of 13 modules	39	5796	1
6077 67	4 row of 13 modules	52	6562	1

Bold Cat.Nos are products normally available with Legrand (India) Stockists. Cat.Nos that are not bold - delivery within 4 - 8 weeks from the date of order. Bold packing quantity is our mandatory packing. Orders to be placed by Legrand (India) Stockist in multiples of the same.

Ekinoxe™ distribution boards

Cat.Nos	Number of ways	LP* ₹ / Unit	Pack
---------	----------------	-----------------	------

Plexo³ boxes for DX³/Lexic

Self-extinguishing: resistance to incandescent wire 650°C
Conform to EN 60439-3
Weatherproof cabinets - IP 65 - IK 09 - Class II
Door and cabinet fully reversible
Removable chassis and faceplates from 2-row versions up
2-position rail for modular products and moulded cases
Spacing between rails 150 mm
Box colour light grey L750A, cover colour dark grey R746A



6019 94

6019 32	2(+1) Module	1622	1
6019 94	4 Module	1544	1
6019 96	6 Module	1764	1
6019 98	8 Module	2206	1



6018 32

Cabinets with 12 modules per row

6018 31	1 row 12 modules	3474	1
6018 32	2 rows 24 modules	4862	1
6018 33	3 rows 36 modules	6714	1

Cabinets with 18 modules per row

6018 35	18 modules x 1 row	4284	1
6018 36	18 modules x 2 rows	7408	1
6018 37	18 modules x 3 rows	10418	1
6018 38	18 modules x 4 rows	16208	1



6018 32 + 0019 17

Multifunction sleeves for P17

0019 17	For 2 row cabinets	2778	1
0019 18	For 3 row cabinets	4168	1
0019 67	Joining kit	810	1

Metra plug and socket DBs

For DX³/Lexic MCBs, RCCBs & RCBOs

With provision for SP/DP/TP MCB

Cat.Nos	Number of ways	No. of modules	LP* ₹ / Unit	Pack
6078 40	10 A SP	1	1450	1
6078 41	20 A SP	1	1558	1
6078 43	20 A DP	2	1696	1
6078 50	20 A TP	3	2874	1
6078 51	32 A TP	3	3408	1



6078 40



6078 60



6078 61

With provision for DP/FP RCCBs / RCBOs

6078 60	20A DP RCBO	4	1644	1
6078 61	20A FP RCBO	8	2870	1
6078 62	32A FP RCBO	8	3384	1

P17 tempra plug and socket DBs

For DX³/Lexic MCBs / RCCBs / RCBOs

6078 70	16A 2P+E-DP	2	2394	1
6078 73	32A 2P+E-DP	2	2582	1
6078 71	32A 3P+E-FP	8	3618	1
6078 72	32A 3P+N+E-FP	8	4702	1
6078 80	63A 3P+N+E-FP	8	11962	1



6078 72

*LP-List Price Inclusive of excise duty but exclusive of sales tax or any other taxes.

#IK - Refer pg - 50 for ready reckoner table.

Ekinoxe™ distribution boards

Cat.Nos	Number of ways	No. of modules	LP* ₹ / Unit	Pack
---------	----------------	----------------	-----------------	------

Metal one way enclosures

For DX³/Lexic MCBs / RCCBs / RCBOs / MCCBs

For independent mounting of MCBs/RCCBs/RCBOs/MCCBs

6078 81	SP Enclosure	1	384	1
6078 82	DP Enclosure	2	562	1
6078 83	TP Enclosure	3	562	1
6078 84	FP Enclosure	4	562	1
6078 85	FP RCBO enclosure	8	952	1
6079 05	DRX 100 MCCB enclosure	3P	1726	1
6079 06	DRX 100 MCCB enclosure	4P	1726	1
6079 44	DPX ³ 160 enclosure MCCB	3P & 4P	3232	1
6079 45	DPX ³ 250 MCCB enclosure	3P & 4P	5740	1
6079 03	DPX 250 MCCB enclosure	3P & 4P	6874	1
6079 04	DPX 630 MCCB enclosure	4P	8702	1



6078 81



6078 84



6078 85

Plastic enclosures for DX³/Lexic

For independent mounting of Lexic MCBs / RCDs / Isolators

Cat.Nos	Number of ways	LP* ₹ / Unit	Pack
0013 56	For 2 poles	178	1
0013 57	For 4 poles	254	1
0013 58	For 6 poles	398	1



Cable end box

For IP 20 DBs

6077 43	For SPN 4 way DB	548	1
6077 53	For SPN 8 way DB	636	1
6077 63	For SPN 12 way DB	706	1
6077 73	For SPN 16 way DB	994	1
6077 83	For ETPN 4 way DB	956	1
6077 73	For ETPN 6 way DB	994	1
6077 93	For ETPN 8 way DB	1776	1
6078 03	For ETPN 12 way DB	2368	1
6078 03	For ETPN 16 way DB	2368	1
6077 63	For all VTPN MCB DB	706	1
6078 13	For all VTPN DPX ³ MCCB DBs	2618	1
6077 63	For all Flexy DBs	706	1



6077 43

For IP 43 DBs

6077 44	For SPN 4 way DB	636	1
6077 54	For SPN 8 way DB	732	1
6077 64	For SPN 12 way DB	824	1
6077 74	For SPN 16 way DB	1164	1
6077 84	For ETPN 4 way DB	1060	1
6077 74	For ETPN 6 way DB	1164	1
6077 94	For ETPN 8 way DB	2040	1



6077 44

Bold Cat.Nos are products normally available with Legrand (India) Stockists. Cat.Nos that are not bold - delivery within 4 - 8 weeks from the date of order. Bold packing quantity is our mandatory packing. Orders to be placed by Legrand (India) Stockist in multiples of the same.

Ekinox™ distribution boards

Cat.Nos	Number of ways	LP* ₹ / Unit	Pack
---------	----------------	--------------	------

Cable end box

For IP 43 DBs

6078 04	For ETPN 12 way DB	2722	1
6078 04	For ETPN 16 way DB	2722	1
6077 64	For all VTPN MCB DB	824	1
6078 14	For all VTPN DPX ³ MCCB DBs	2946	1
6077 64	For all Flexy DBs	824	1

Meter box

Provision for mounting Ammeter/Voltmeter/
Ammeter selector switch/ Voltmeter selector switch



6077 75

6077 75	For all VTPN DPX ³ MCCB IP 20 DB	3962	1
6077 76	For all VTPN DPX ³ MCCB IP 43 DBs	4752	1
6077 77	For all VTPN DPX ³ MCCB IP 54 DBs	5520	1

Per phase isolation kit

6078 90	PPI conversion kit for ETPN 4 way DB	2036	1
6078 91	PPI conversion kit for ETPN 6 way DB	2292	1
6078 92	PPI conversion kit for ETPN 8 way DB	2682	1
6078 93	PPI conversion kit for ETPN 12 way DB	2990	1
6078 94	PPI conversion kit for ETPN 16 way DB	3326	1

Panel locks



6078 95

6078 95	Panel lock for IP 43 SPN DBs	366	1
6078 96	Panel lock for IP 54 SPN DBs	390	1
6078 97	Panel lock for IP 43 ETPN, VTPN MCB, DPX ³ MCCB & Flexy DBs	488	1
6078 98	Panel lock for IP 54 ETPN, VTPN MCB, DPX ³ MCCB & Flexy DBs	514	1

*LP - List Price Inclusive of excise duty but exclusive of sales tax or any other taxes.

Distribution boards

Cat.Nos	No. of devices connected	No. of 17.5 mm modules	LP* ₹ / Unit	Pack
---------	--------------------------	------------------------	--------------	------

Supply busbars - insulated

100 A copper

Pin type

SP I/C & SP O/G

4049 26	13	13	280	1
4049 37	57	57	1082	1

SPN I/C & SPN O/G

4049 38	6	12	492	1
4049 39	28	56	2022	1

TPN I/C & SPN O/G

4049 40	5	12	506	3/30
4049 41	27	56	4940	5/10

TP I/C & TP O/G

4049 42	4	12	506	1
4049 43	19	57	4940	1

FP I/C & FP O/G

4049 44	3	12	1216	3/30
4049 45	14	56	4940	5/10

Fork type

SP I/C & SP O/G

4049 11	13	12	280	1
4049 12	57	57	1058	1

SPN I/C & SPN O/G250

4049 14	28	56	2022	1
---------	----	----	------	---

TP I/C & TP O/G

4049 17	4	12	506	1
4049 18	19	57	4940	1

FP I/C & FP O/G

4049 20	14	56	4940	5/10
---------	----	----	------	------

Cat.Nos	Description	LP* ₹ / Unit	Pack
---------	-------------	--------------	------

Accessories for fork and pin type busbars

4049 89	End caps for SP	8	6
4049 90	End caps for DP & TP	30	6
4049 91	End caps for FP	60	20/840

Cat.Nos	Number of ways	LP* ₹ / Unit	Pack
---------	----------------	--------------	------

Blanking plates

6014 70G	-	16	10
----------	---	----	----

Bold Cat.Nos are products normally available with Legrand (India) Stockists. Cat.Nos that are not bold - delivery within 4 - 8 weeks from the date of order. Bold packing quantity is our mandatory packing. Orders to be placed by Legrand (India) Stockist in multiples of the same.

Ekinox DBs

For Converting ETPN DB to PPI DB

PPI DB IP 20 - IK 08

No. of ways	Combine		No. of modules
	ETPN DB	PPI Kit	
4 way	4 way 607705	4 way kit 607890	8+12
6 way	6 way 607706	6 way kit 607891	8+18
8 way	8 way 607707	8 way kit 607892	8+24
12 way	12 way 607708	12 way kit 607893	8+36
16 way	16 way 607709	16 way kit 607894	8+48

PPI DB IP 43 - IK 09 with metal door

No. of ways	Combine		No. of modules
	ETPN DB	PPI Kit	
4 way	4 way 607715	4 way kit 607890	8+12
6 way	6 way 607716	6 way kit 607891	8+18
8 way	8 way 607717	8 way kit 607892	8+24
12 way	12 way 607718	12 way kit 607893	8+36
16 way	16 way 607719	16 way kit 607894	8+48

PPI DB IP 43 - IK 09 with acrylic door

No. of ways	Combine		No. of modules
	ETPN DB	PPI Kit	
4 way	4 way 607725	4 way kit 607890	8+12
6 way	6 way 607726	6 way kit 607891	8+18
8 way	8 way 607727	8 way kit 607892	8+24
12 way	12 way 607728	12 way kit 607893	8+36
16 way	16 way 607729	16 way kit 607894	8+48

PPI DB IP 54 - IK 09

No. of ways	Combine		No. of modules
	ETPN DB	PPI Kit	
4 way	4 way 607735	4 way kit 607890	8+12
6 way	6 way 607736	6 way kit 607891	8+18
8 way	8 way 607737	8 way kit 607892	8+24
12 way	12 way 607738	12 way kit 607893	8+36
16 way	16 way 607739	16 way kit 607894	8+48

IK

Protection against mechanical impact: protection index - IK

According to standard:

IEC 62262, BS EN 62262 and NF EN 62262

• This table can be used to ascertain the resistance of a product to an impact given in Joules from the IK code (graduated from 00 to 10)

It can also be used to ascertain the correspondence with the old IP code 3rd digit and the corresponding external "Ag" conditions

IK	Tests	Impact energy [in Joules]	"AG" of NF C 15-100
IK 00		0	
IK 01		0.15	
IK 02		0.2	AG1
IK 03		0.35	
IK 04		0.5	
IK 05		0.7	
IK 06		1	
IK 07		2	AG2
IK 08		5	AG3
IK 09		10	
IK 10		20	AG4

IPXX

Index of protection

IP*** index of protection of enclosures of electrical equipment in accordance with standards IEC 529, BS 5490, DIN 400 50 and NF C 20-010

Up to 1000 V± and 1500 V= (standard UTE C 20 010)

1st figure:- protection against solid bodies

IP	tests	
0		No protection
1		Protected against solid bodies larger than 50 mm (eg:- accidental contact with the hand)
2		Protected against solid bodies larger than 12 mm (eg:- finger)
3		Protected against solid bodies larger than 2.5 mm (eg:- tools, wires)
4		Protected against solid bodies larger than 1 mm (eg:- fine tools and small wires)
5		Protected against dust (no harmful deposit)
6		Completely protected against dust

2nd figure:- protection against liquids

IP	tests	
0		No protection
1		Protected against vertically-falling drops of water (condensation)
2		Protected against drops of water falling at up to 15° from the vertical
3		Protected against drops of rain water at up to 60° from the vertical
4		Protected against projections of water from all directions
5		Protected against jets of water from all directions
6		Protected against jets of water of similar force to heavy seas
7		Protected against the effects of immersion
8		Protected against prolonged effects of immersion under pressure

The contents of all the above charts are for guidance only, if you have any doubt as to the interpretation of the information contained therein, please refer either to the standard itself or contact Legrand.

In accordance with our policy of continuous improvement, Legrand reserves the right to change specifications and designs without notice. All information given here is correct at the time of going to press.

P17 Tempra and Hypra Plugs and Sockets

For safe connection which you can depend on.
Ensures the protection of personnel at electrical installation

P17 Tempra
plugs and
sockets



Hypra prisinter
and Hypra plugs
and sockets



P17 Tempra
combined
units



Metra
metallic
plugs and
sockets



Metallic
plug and
socket DB's



P17 Tempra Pro IP 44 - LV 16 and 32 A - sockets and plugs

Cat.Nos	Description	MRP* ₹ / Unit	Pack
NEW! Surface mounting sockets			
5551 54	200/250 V~, 16 A 2P+E	546	10
5551 58	380/415 V~, 16 A 3P+E	690	10
5551 59	380/415 V~, 16 A 3P+N+E	690	10
5552 54	200/250 V~, 32 A 2P+E	690	5
5552 58	380/415 V~, 32 A 3P+E	872	10
5552 59	380/415 V~, 32 A 3P+N+E	872	10
NEW! Panel mounting sockets inclined outlet			
5551 84	200/250 V~, 16 A 2P+E	328	10
5551 88	380/415 V~, 16 A 3P+E	510	10
5551 89	380/415 V~, 16 A 3P+N+E	510	10
5551 84	200/250 V~, 32 A 2P+E	536	10
5551 88	380/415 V~, 32 A 3P+E	676	10
5551 89	380/415 V~, 32 A 3P+N+E	676	10
NEW! Mobile sockets			
5551 04	200/250 V~, 16 A 2P+E	426	10
5551 08	380/415 V~, 16 A 3P+E	500	10
5551 09	380/415 V~, 16 A 3P+N+E	500	10
5552 14	200/250 V~, 32 A 2P+E	572	10
5552 18	380/415 V~, 32 A 3P+E	718	10
5552 19	380/415 V~, 32 A 3P+N+E	718	10
NEW! Straight plugs			
5551 24	200/250 V~, 16 A 2P+E	302	10
5551 28	380/415 V~, 16 A 3P+E	390	10
5551 29	380/415 V~, 16 A 3P+N+E	392	10
5552 34	200/250 V~, 32 A 2P+E	476	10
5552 38	380/415 V~, 32 A 3P+E	554	10
5552 39	380/415 V~, 32 A 3P+N+E	554	10
P17 Tempra - domestic pin configuration 16 A - 250 V~			
Flush-mounting boxes			
0577 21	For 2 panel mounting sockets With single fixing centres 70 x 70 mm - 16 A	3174	3
0577 22	For 1 panel mounting socket With single fixing centres 70 x 70 mm - 16 or 32 A (32 A to be fixed horizontally)	1904	3

* MRP - Maximum Retail Price Inclusive of all taxes.
Red Cat.Nos - new products

P17 Tempra Plugs & Sockets

Clip it on - it is locked...

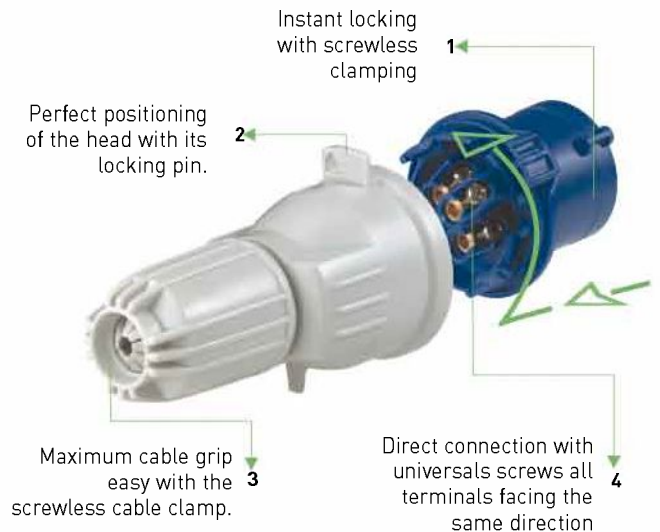

- The larger body size makes wiring very easy



- Maximum safety: The elongated earth pin is disconnected last.



- For surface mounting sockets: The unit clips directly onto the base.

Bold Cat.Nos are products normally available with Legrand (India) Stockists. Cat.Nos that are not bold - delivery within 4 - 8 weeks from the date of order. Bold packing quantity is our mandatory packing. Orders to be placed by Legrand (India) Stockist in multiples of the same.

P17 Tempra Pro IP 66/67 LV 16 and 32 A

Cat.Nos	Polarity	MRP* ₹ / Unit	Pack
NEW! Surface mounting sockets			
5553 54	200/250 V~, 16 A 2P+E	890	5
5553 58	380/415 V~, 16 A 2P+E	1128	5
5553 59	380/415 V~, 16 A 3P+N+E	1128	5
5554 54	200/250 V~, 32 A 2P+E	1090	5
5554 55	200/250 V~, 32 A 2P+E	2072	5
5554 59	380/415 V~, 32 A 3P+N+E	2072	5

NEW! Panel mounting sockets

5553 84	200/250 V~, 16 A 2P+E	652	5
5553 88	380/415 V~, 16 A 2P+E	728	5
5553 89	380/415 V~, 16 A 3P+N+E	728	5
5554 84	200/250 V~, 32 A 2P+E	828	5
5554 88	380/415 V~, 32 A 2P+E	1000	5
5554 89	380/415 V~, 32 A 3P+N+E	1000	5

NEW! Mobile sockets

5553 04	200/250 V~, 16 A 2P+E	796	5
5553 08	380/415 V~, 16 A 2P+E	1046	5
5553 09	380/415 V~, 16 A 3P+N+E	1046	5
5554 14	200/250 V~, 32 A 2P+E	1092	5
5554 18	380/415 V~, 32 A 2P+E	1230	5
5554 19	380/415 V~, 32 A 3P+N+E	1230	5

NEW! Straight plugs

5553 24	200/250 V~, 16 A 2P+E	696	5
5553 28	380/415 V~, 16 A 2P+E	800	5
5553 29	380/415 V~, 16 A 3P+E	800	5
5554 34	200/250 V~, 32 A 2P+E	988	5
5554 38	380/415 V~, 32 A 2P+E	1040	5
5554 39	380/415 V~, 32 A 3P+E	1040	5



5553 28



0587 05

P17 Tempra Pro IP 66/67 LV 32 A for refrigerated containers

Combined unit, plug and mobile socket for refrigerated containers

6571 06	Combined unit with interlocked switched socket - Double mechanical interlock - Cable glands are not supplied	14682	1
---------	--	-------	---



6571 06

* MRP - Maximum Retail Price Inclusive of all taxes.
Red Cat.Nos - new products

P17 Tempra Pro IP 66/67 LV 32 A for refrigerated containers

Cat.Nos	Polarity	MRP* ₹ / Unit	Pack
NEW! Combined unit, plug and mobile socket for refrigerated containers			
5554 91	Panel mounting socket	1200	5
5554 21	Mobile socket With cable grip Ø12 to 21.5 mm	1458	5
5554 41	Straight plug With cable grip Ø12 to 21.5 mm	1182	5

P17 Tempra IP 66/67 - LV 63 and 125 A

Surface mounting sockets

0587 40	200/250 V~, 63 A 2P+E	3772	2
0587 44	380/415 V~, 63 A 3P+E	3860	2
0587 45	380/415 V~, 63 A 3P+N+E	3860	2
0591 06	380/415 V~, 125 A 3P+E	11242	2
0591 07	380/415 V~, 125 A 3P+N+E	11242	2

Panel mounting sockets

0587 20	200/250 V~, 63 A 2P+E	3140	2
0587 24	380/415 V~, 63 A 3P+E	3140	2
0587 25	380/415 V~, 63 A 3P+N+E	2952	2
0591 16	380/415 V~, 125 A 3P+E	8796	1
0591 17	380/415 V~, 125 A 3P+N+E	8796	1

Straight plugs

0587 00	200/250 V~, 63 A 2P+E	2648	2
0587 04	380/415 V~, 63 A 3P+E	2648	2
0587 05	380/415 V~, 63 A 3P+N+E	2738	2
0591 26	380/415 V~, 125 A 3P+E	7882	1
0591 27	380/415 V~, 125 A 3P+N+E	7882	1

Mobile sockets

0587 10	200/250 V~, 63 A 2P+E	3492	2
0587 14	380/415 V~, 63 A 3P+E	3492	2
0587 15	380/415 V~, 63 A 3P+N+E	3492	2
0591 36	380/415 V~, 125 A 3P+E	11470	1
0591 37	380/415 V~, 125 A 3P+N+E	11470	1



0587 14

Bold Cat.Nos are products normally available with Legrand (India) Stockists. Cat.Nos that are not bold - delivery within 4 - 8 weeks from the date of order. Bold packing quantity is our mandatory packing. Orders to be placed by Legrand (India) Stockist in multiples of the same.

Plugs and sockets

Cat.Nos	Polarity	LP* ₹ / Unit	Pack
---------	----------	--------------------	------

P17 combined unit to be equipped Bases with mechanical super-compact sockets

0573 00	16 A, 2P+E IP 44 Interlock	3882	1
0573 02	16 A, 3P+N+E IP 44 Interlock	4160	1
0573 20	16 A, 2P+E IP 55 Interlock	4354	1
0573 22	16 A, 3P+N+E IP 55 Interlock	4898	1
0577 23	Mounting plate for 2 super-compact mechanical interlock sockets	2176	1

Bases for 125 x 220 mm face plates

0577 10	Surface mounting box - upto 2 sockets	856	2
0589 38	Surface mounting box with 5 module dinrail - upto 2 sockets	2418	1
0577 05	Surface mounting box with 12 module dinrail - upto 4 sockets	5284	1
0577 06	Surface mounting box with 18 module dinrail - upto 6 sockets	7400	1

Face plates 125 x 220 mm without sockets

0577 12	For 1 x 16 A or 32 - upto A socket	822	5
0577 13	For 2 x 16 A - upto sockets	1082	5
0577 17	For 1 x 63 A - upto sockets	990	5
0577 15	Blanking Plate	732	5

Bases for 125 x 280 mm faceplates

0577 11	Surface mounting box - upto 3 sockets	892	3
0577 20	Surface mounting box with 5 module dinrail - upto 3 sockets	2720	1
0577 03	Surface mounting box with 12 module dinrail - upto 6 sockets	5480	1
0577 04	Surface mounting box with 18 module dinrail - upto 9 sockets	7624	1

Face plates 125 x 280 mm without sockets

0577 18	For 2 x 16 A and / or 32 A sockets	1284	4
0577 19	For 1 x 16 A or 32 A socket and 1 x 63 A socket	1268	2
0577 14	For 3 x 16 A sockets	1468	4
0577 16	Blanking plate	856	4

*LP - List Price Inclusive of excise duty but exclusive of sales tax or any other taxes.

Hypra industrial plugs and sockets

Cat.Nos	Polarity	LP* ₹ / Unit	Pack
---------	----------	--------------------	------

Sockets

Prisinter panel mounting sockets - IP 44, IK 09

0520 02	230 V, 16 A, 2P+E	11052	1/10
0527 02	230 V, 32 A, 2P+E	11590	1/6
0529 03	415 V, 32 A, 3P+E	11540	1/6
0529 04	415 V, 32 A, 3P+N+E	14118	1/6
0536 04	415 V, 63 A, 3P+N+E	35156	1

Panel mounting sockets - inclined IP 44, IK 09

0522 23	415 V, 16 A, 3P+E	1730	5/50
0538 23	415 V, 63 A, 3P+E	5244	1

Mobile sockets - IP 44, IK 09

0522 83	415 V, 16 A, 3P+E	3958	5/50
---------	-------------------	------	------

Plugs

Straight plugs - IP 44, IK 09

0520 42	250 V, 16 A, 2P+E	1808	5/50
0527 42	250 V, 32 A, 2P+E	2328	1/5
0522 43	415 V, 16 A, 3P+E	3072	5/50
0529 43	415 V, 32 A, 3P+E	2836	5/50
0529 44	415 V, 32 A, 3P+N+E	3238	5/15
0538 43	415 V, 63 A, 3P+E	7500	1/5
0538 44	415 V, 63 A, 3P+N+E	10472	1/5

Metra plugs and sockets

Plugs

Ivory

6500 22	240 V, 10 A, 2P+E	148	1/5/100
6500 28	240 V, 20 A, 2P+E	158	1/5/100

Grey

6500 02	240 V, 10 A, 2P+E	148	1/5/100
6500 08	240 V, 20 A, 2P+E	158	1/5/100
6500 10	440 V, 20 A, 3P+E	212	1/5/100
6500 16	440 V, 32 A, 3P+E	394	1/5/100

Sockets

6500 03	240 V, 10 A, 2P+E With blue cap	152	1/5/100
6500 23	240 V, 10 A, 2P+E With ivory cap	152	1/5/100
6500 09	240 V, 20 A, 2P+E With blue cap	172	1/5/100
6500 29	240 V, 20 A, 2P+E With ivory cap	172	1/5/100
6500 11	440 V, 20 A, 3P+E With red cap	232	1/5/100
6500 17	440 V, 32 A, 3P+E With red cap	394	1/5/100

Bold Cat.Nos are products normally available with Legrand (India) Stockists. Cat.Nos that are not bold - delivery within 4 - 8 weeks from the date of order. Bold packing quantity is our mandatory packing. Orders to be placed by Legrand (India) Stockist in multiples of the same.

P17 Tempra Combined Units

closed... it's connected!

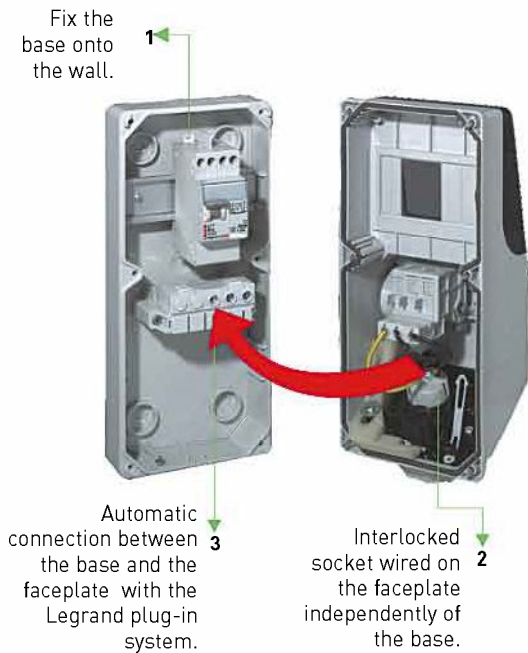

- **Transparent window**
For quick viewing of protection devices.



- **Din rail**
For full access to all Legrand Lexic modular functions upto 5 module.



- **Double interlock**
Switch cannot be turned on unless a plug has been inserted [1st safety position]. Plug cannot be removed when the switch is on [2nd safety position].

Refer p. 133

NOTES :

- All prices listed in this price list except Lexic MCBs (p. 37-38), Arteor™, Myrius™, Mylinc™ and Colour Door Entry Kits are given as List Price (LP) which is inclusive of Excise Duty but exclusive of Sales Tax or any other taxes. Sales Tax and local levies such as octroi, as applicable, will be charged at actuals.
- The prices of Lexic MCBs (p. 37-38), Arteor™, Myrius™ & Mylinc™, Wiring Accessories are given as Maximum Retail Price (MRP) which is inclusive of all taxes.
- The prices of DMX³ ACB (p. 7-10) and LCS² Structured Cabling System (p. 116-128), are available on request. The prices of Arteor™ selected products (66-77) are also available on request.
- All prices are ex our works packed in paper cartons.
- Prices subject to change without notice. Prices charged will be as ruling at time of delivery. Any increase in statutory duty like excise will be to customer's account.
- All distribution boards, plug & socket enclosures, metal / plastic one-way enclosures are supplied without devices.
- Arteor™, Myrius™ & Mylinc™ cover plates, DLP trunking, floor boxes, pop-up boxes, Power & data desk grommets, Desktop multi-extension outlets and VDI distribution blocks are supplied without mechanisms.



Astro Rex Time Switches
Ideal for street lighting applications

Refer p. 35

Legrand

a global edifice

Legrand is global specialist in electrical and digital building infrastructures. The Group's headquarter is based at Limoges, France. Legrand (India), the pioneer of Miniature Circuit Breakers in India, is the Indian subsidiary of Legrand Group. The Group services the needs of residential, commercial, hospitality and industrial sectors.

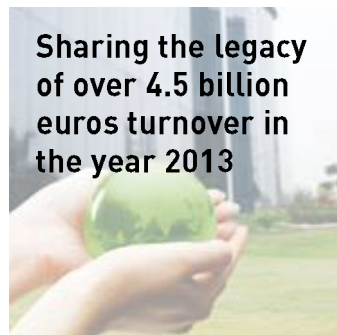
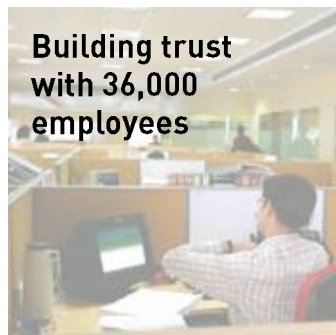

- Manufacturing facilities in 70 countries and sale of products in 180 countries.
- The only company manufacturing low voltage electrical equipments complying to all the important world standards
- World leader in wiring devices and cable management.
- The group designs and manufactures over 98 product families comprising of 1,78,000 products annually, with due emphasis on high performance, simplified installation and user convenience.
- Close to 1/3 of Legrand's capital expenditure is dedicated to the development of new products.
- Every year, Legrand invests around 5% of its global turnover on research and development activities involving over 2100 people worldwide.

Legrand Group Values

Customer Awareness



Innovation



Resource Enhancement



Ethical Behaviour



Legrand prestigious projects

- > Some of the prestigious projects we have been proud to associate with.
- > The group services the needs of residential, commercial, hospitality and industrial projects.

NORTH



Orient Taj - Agra



Ranbaxy - Gurgaon



DLF's Magnolias - Gurgaon

EAST



City Centre 2 - Kolkata



Mani Square - Kolkata



Uniworl City - Kolkata

WEST



Park Plaza - Mumbai



Wankhede Stadium - Mumbai



Kalpataru Aura - Mumbai

SOUTH



Accenture - Chennai



Nokia - Siemens Network - Chennai



Plaza Reality - Green Acres - Chennai

CENTRAL



Green City - Vizag



Vishnunivasa - Trimula



Apollo DB City - Indore

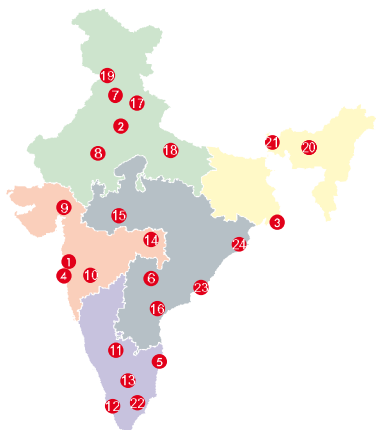

Head office

- 61 & 62, 6th Floor,
Kalpataru Square, Kondivita Road,
Off Andheri-Kurla Road, Andheri (E),
MUMBAI - 400 059.
Tel : [022] 3041 6200
Fax : [022] 3041 6201
Website : www.legrand.co.in

Regional sales offices

- A-25, Mohan Co-operative
Industrial Estate, Mathura Road,
NEW DELHI - 110 044.
Tel : [011] 2699 0028 / 29 / 30, 3990 2200
Fax : [011] 2699 0047
- Bhakta Towers, 2nd & 3rd Floor,
Plot No. KB 22, Salt Lake, Sector - 3,
KOLKATA - 700 098.
Tel : [033] 4021 3535 / 36
Fax : [033] 4021 3537
- 34, 3rd Floor, Kalpataru Square,
Kondivita Road, Off Andheri-Kurla Road,
Andheri (East),
MUMBAI - 400 059.
Tel : [022] 3385 6200
Fax : [022] 3385 6201
- Gee Gee Universal,
8th Floor, Door No. 2, 18/1 & 18/2,
McNichols Road, Chetput,
CHENNAI - 600 031.
Tel : [044] 3024 7200, 2836 4165 / 67 / 68
Fax : [044] 2836 4169
- 205-208, 2nd Floor, Block - II,
White House, Kundan Bagh, Begumpet,
HYDERABAD - 500 016.
Tel : [040] 2341 4398 / 67, 4567 1717
Fax : [040] 6636 6974

Branch offices

- SCO 1-2-3,
Second Floor, Sector 17B,
CHANDIGARH - 160 017.
Tel : [0172] 305 8631 / 32 / 33 / 34 / 35
Fax : [0172] 501 9008
- 507-510, Vth Floor, Soni Paris Point,
Jai Singh Highway, Banipark,
JAIPUR - 302 016.
Telefax : [0141] 511 3129
- 504, Sakar IV,
Opp. M. J. Library, Ellis Bridge,
AHMEDABAD - 380 006. Gujarat
Tel : [079] 2658 6561 / 2
Fax : [079] 2658 6563
- 402, Swastik Chambers,
Near Ashwamegh Marriage Hall,
Behind HP Petrol Pump,
Off Karve Road, Erandwane,
PUNE - 411 004.
Tel : [020] 6729 5600 / 601
Fax : [020] 6729 5604
- 11nd Floor, Al-Latheef Building,
2/1, Union Street, Off. Infantry Road,
BANGALORE - 560 001.
Tel : [080] 2286 1081, 4113 3293 / 4
Fax : [080] 2286 1078
- No. 36/2178, Syda Building, 2nd Floor,
Kaloor - Kadavanthra Road, Kaloor,
KOCHI - 682 017.
Tel : [0484] 234 2921, 658 0921
Fax : [0484] 233 3921
- B-15, Thirumalai Towers,
IV-D, Fourth Floor,
723, Avanashi Road,
COIMBATORE - 641 018.
Tel : [0422] 650 2728, 222 3634 / 0283
Fax : [0422] 222 3164
- Plot No.95, II Floor, Shreyash Heights,
Ramdas Peth, VIP Road,
NAGPUR - 440 010.
Tel : [0712] 662 7857 / 58
Fax : [0712] 662 7859
- 204-205, Megapolis Square,
579, M G Road,
INDORE - 452 001.
Tel : [0731] 393 1650 / 51 / 52
Fax : [0731] 393 1653
- MF-2, Datta's Lords House,
Jammi Chettu Street,
VIJAYAWADA - 520 010.
Tel : [0866] 661 1393, 664 6393
Fax : [0866] 669 9393

Area offices

- ABC Business Club 16,
Tagore Villa,
Chakrata Road,
DEHRADUN - 248 001.
Uttaranchal.
Tel : [0135] 271 5189 / 248 001
- Cabin No.104/105,
Trade Point,
Ground Floor,
Saran Chamber 1,
5, Park Road, Hazratganj,
LUCKNOW - 226 001.
Tel : [0522] 223 9044 / 7285
Fax : [0522] 223 9124
- Cabin No. 9,
Second Floor,
Madhok Trade Centre,
Madhok Complex,
Ferozpur Road,
LUDHIANA - 141 001.
Tel/Fax No.: [0161] 277 0301 / 304
- House No. 97,
Ground Floor,
Rajgarh Main Road,
Opp. City Heart Nursing Home,
GUWAHATI - 781 007.
Tel : [0361] 245 8498
- 94, Udham Singh Sarani,
Ground Floor, Ashrampara,
SILIGURI - 734 001.
Tel : 94341 91635 / 98009 77780
- Aparna Towers, 1st Floor,
2/3, Bypass Road,
MADURAI - 625 010.
Telefax : [0452] 230 8414
- 404, Eshwar Plaza,
Dwaraka Nagar, Main Road,
VISHAKHAPATNAM - 530 020.
Tel : [0891] 663 5652
Fax : [0891] 663 9363
- Plot No. 359,
Saheed Nagar, 2nd Floor,
BHUBANESWAR - 751 007.
Tel : [0674] 254 0623

Technical assistance from Legrand

Telephonic technical assistance for selection of products, technical information, guidance, wiring diagrams and estimation is now made available to you at each Regional Office. Contact the Technical Officer of Legrand at the following telephone numbers

- New Delhi** : Tel.: [011] 2699 0028, 3990 2200
Kolkata : Tel.: [033] 4021 3535 / 36
Mumbai : Tel.: [022] 3385 6200
Chennai : Tel.: [044] 3024 7200, 2836 4165 / 67 / 68
Hyderabad : Tel.: [040] 2341 4398 / 67, 4567 1717

For other places, contact the nearest
Regional / Branch / Area offices

customer.care@legrand.co.in

